



DS-6900UDI Series
HD Video and Audio Decoder

User Manual

User Manual

COPYRIGHT ©2019 Hangzhou Hikvision Digital Technology Co., Ltd.

ALL RIGHTS RESERVED.

Any and all information, including, among others, wordings, pictures, graphs are the properties of Hangzhou Hikvision Digital Technology Co., Ltd. or its subsidiaries (hereinafter referred to be "Hikvision"). This user manual (hereinafter referred to be "the Manual") cannot be reproduced, changed, translated, or distributed, partially or wholly, by any means, without the prior written permission of Hikvision. Unless otherwise stipulated, Hikvision does not make any warranties, guarantees or representations, express or implied, regarding to the Manual.

About this Manual

This Manual is applicable to DS-6900UDI Decoder.

The Manual includes instructions for using and managing the product. Pictures, charts, images and all other information hereinafter are for description and explanation only. The information contained in the Manual is subject to change, without notice, due to firmware updates or other reasons. Please find the latest version in the company website (<http://overseas.hikvision.com/en/>).

Please use this user manual under the guidance of professionals.

Trademarks Acknowledgement

HIKVISION and other Hikvision's trademarks and logos are the properties of Hikvision in various jurisdictions. Other trademarks and logos mentioned below are the properties of their respective owners.

Legal Disclaimer

TO THE MAXIMUM EXTENT PERMITTED BY APPLICABLE LAW, THE PRODUCT DESCRIBED, WITH ITS HARDWARE, SOFTWARE AND FIRMWARE, IS PROVIDED "AS IS", WITH ALL FAULTS AND ERRORS, AND HIKVISION MAKES NO WARRANTIES, EXPRESS OR IMPLIED, INCLUDING WITHOUT LIMITATION, MERCHANTABILITY, SATISFACTORY QUALITY, FITNESS FOR A PARTICULAR PURPOSE, AND NON-INFRINGEMENT OF THIRD PARTY. IN NO EVENT WILL HIKVISION, ITS DIRECTORS, OFFICERS, EMPLOYEES, OR AGENTS BE LIABLE TO YOU FOR ANY SPECIAL, CONSEQUENTIAL, INCIDENTAL, OR INDIRECT DAMAGES, INCLUDING, AMONG OTHERS, DAMAGES FOR LOSS OF BUSINESS PROFITS, BUSINESS INTERRUPTION, OR LOSS OF DATA OR DOCUMENTATION, IN CONNECTION WITH THE USE OF THIS PRODUCT, EVEN IF HIKVISION HAS BEEN ADVISED OF THE POSSIBILITY OF SUCH DAMAGES.

REGARDING TO THE PRODUCT WITH INTERNET ACCESS, THE USE OF PRODUCT SHALL BE WHOLLY AT YOUR OWN RISKS. HIKVISION SHALL NOT TAKE ANY RESPONSIBILITIES FOR ABNORMAL OPERATION, PRIVACY LEAKAGE OR OTHER DAMAGES RESULTING FROM CYBER ATTACK, HACKER ATTACK, VIRUS INSPECTION, OR OTHER INTERNET SECURITY RISKS; HOWEVER, HIKVISION WILL PROVIDE TIMELY TECHNICAL SUPPORT IF REQUIRED.

SURVEILLANCE LAWS VARY BY JURISDICTION. PLEASE CHECK ALL RELEVANT LAWS IN YOUR JURISDICTION BEFORE USING THIS PRODUCT IN ORDER TO ENSURE THAT YOUR USE CONFORMS THE APPLICABLE LAW. HIKVISION SHALL NOT BE LIABLE IN THE EVENT THAT THIS PRODUCT IS USED WITH ILLEGITIMATE PURPOSES.

IN THE EVENT OF ANY CONFLICTS BETWEEN THIS MANUAL AND THE APPLICABLE LAW, THE LATER PREVAILS.

Regulatory information

FCC information

Please take attention that changes or modification not expressly approved by the party responsible for compliance could void the user's authority to operate the equipment.

FCC compliance: This equipment has been tested and found to comply with the limits for a Class A digital device, pursuant to part 15 of the FCC Rules. These limits are designed to provide reasonable protection against harmful interference when the equipment is operated in a commercial environment. This equipment generates, uses, and can radiate radio frequency energy and, if not installed and used in accordance with the instruction manual, may cause harmful interference to radio communications. Operation of this equipment in a residential area is likely to cause harmful interference in which case the user will be required to correct the interference at his own expense.

FCC conditions

This device complies with part 15 of the FCC Rules. Operation is subject to the following two conditions:

1. This device may not cause harmful interference.
2. This device must accept any interference received, including interference that may cause undesired operation.

EU Conformity Statement

 This product and - if applicable - the supplied accessories too are marked with "CE" and comply therefore with the applicable harmonized European standards listed under the EMC Directive 2014/30/EU, the LVD Directive 2014/35/EU, the RoHS Directive 2011/65/EU.

 2012/19/EU (WEEE directive): Products marked with this symbol cannot be disposed of as unsorted municipal waste in the European Union. For proper recycling, return this product to your local supplier upon the purchase of equivalent new equipment, or dispose of it at designated collection points. For more information see: www.recyclethis.info

 2006/66/EC (battery directive): This product contains a battery that cannot be disposed of as unsorted municipal waste in the European Union. See the product documentation for specific battery information. The battery is marked with this symbol, which may include lettering to indicate cadmium (Cd), lead (Pb), or mercury (Hg). For proper recycling, return the battery to your supplier or to a designated collection point. For more information see: www.recyclethis.info

Industry Canada ICES-003 Compliance



This device meets the CAN ICES-3 (A)/NMB-3(A) standards requirements.

Applicable Model

Series	Model
DS-6900UDI Decoder	DS-6901UDI
	DS-6904UDI
	DS-6908UDI
	DS-6910UDI
	DS-6912UDI
	DS-6916UDI

Symbol Conventions

The symbols that may be found in this document are defined as follows.

Symbol	Description
 NOTE	Provides additional information to emphasize or supplement important points of the main text.
 WARNING	Indicates a potentially hazardous situation, which if not avoided, could result in equipment damage, data loss, performance degradation, or unexpected results.
 DANGER	Indicates a hazard with a high level of risk, which if not avoided, will result in death or serious injury.

Safety Instructions

- Proper configuration of all passwords and other security settings is the responsibility of the installer and/or end-user.
- In the use of the product, you must be in strict compliance with the electrical safety regulations of the nation and region. Please refer to technical specifications for detailed information.
- Input voltage should meet both the SELV (Safety Extra Low Voltage) and the Limited Power Source with 100 to 240 VAC or 12 VDC according to the IEC60950-1 standard. Please refer to technical specifications for detailed information.
- Do not connect several devices to one power adapter as adapter overload may cause overheating or a fire hazard.
- Please make sure that the plug is firmly connected to the power socket.
- If smoke, odor or noise rise from the device, turn off the power at once and unplug the power cable, and then please contact the service center.

Preventive and Cautionary Tips

Before connecting and operating your device, be advised of the following tips:

- Ensure unit is installed in a well-ventilated, dust-free environment.
- Unit is designed for indoor use only.
- Keep all liquids away from the device.
- Ensure environmental conditions meet factory specifications.
- Ensure unit is properly secured to a rack or shelf. Major shocks or jolts to the unit as a result of dropping it may cause damage to the sensitive electronics within the unit.
- Use the device in conjunction with an UPS if possible.
- Power down the unit before connecting and disconnecting accessories and peripherals.
- Improper use or replacement of the battery may result in explosion. Replace with the same or equivalent type only. Dispose of used batteries according to the instructions provided by the battery manufacturer.

Table of Contents

Chapter 1 Introduction	1
1.1 Description	1
1.2 Features.....	1
Chapter 2 Panels and Connections	3
2.1 Front Panel	3
2.2 Rear Panel.....	5
Chapter 3 Device Activation.....	8
3.1 Activating via SADP Software	8
3.2 Activating via Web Browser	9
3.3 Activating via Client Software.....	10
Chapter 4 Network Configuration	13
4.1 Configuring Basic Network Settings.....	14
4.2 Configuring DDNS Settings	15
4.3 Configuring Security Control	17
Chapter 5 Decoding Parameters Configuration	19
5.1 Configuring Stream Settings.....	19
5.2 Configuring Transparent Channel	19
5.3 Configuring Synchronous Output Settings	20
5.4 Configuring Personalized Settings	21
Chapter 6 Decoding Operation.....	23
6.1 Configuring Encoding Devices	23
6.1.1 Adding an Encoding Device	23
6.1.2 Modifying an Encoding Device	26
6.1.3 Deleting an Encoding Device	27
6.2 Configuring Video Wall	27
6.3 Configuring Decoding Output.....	28
6.3.1 Configuring BNC Output	29
6.3.2 Configuring HDMI Output	30
6.4 Decoding Video on Video Wall	32
6.4.1 Interface Description.....	32
6.4.2 Dragging Channels to the Video Wall.....	33
6.4.3 Opening Window via Coordinate.....	34

6.4.4 Managing Decoding	36
6.4.5 Switching Encoding Channel.....	38
6.4.6 Configuring Auto-Switch of Cameras	39
6.4.7 Roaming Window.....	39
6.4.8 Zooming in/out Roaming Windows	40
6.4.9 Configuring Scene	42
Chapter 7 User Management	44
Chapter 8 System Configuration	46
8.1 Checking Device Information	46
8.2 Configuring Time Settings	46
8.3 Configuring RS-232 Serial Port	48
8.4 Configure RS-485 Serial Port	49
Chapter 9 System Maintenance.....	50
9.1 Importing Configuration Files.....	50
9.2 Exporting Configuration Files	50
9.3 Upgrading the Device.....	51
9.4 Restoring the Default Settings.....	51
9.5 Rebooting the Device.....	51
Chapter 10 Decoder Configuration and Operation by Client Software	52
10.1 Interface Description	52
10.2 Adding an Encoding/Decoding Device.....	53
10.3 Configuring Video Wall	55
10.3.1 Adding a Video Wall	55
10.3.2 Modifying a Video Wall	56
10.3.3 Deleting a Video Wall	56
10.3.4 Configuring Virtual Screen.....	57
10.4 Configuring Decoding Parameters	59
10.5 Configuring Decoding Output.....	60
10.5.1 Configuring BNC Output	60
10.5.2 Configuring HDMI Output.....	62
10.6 Operating Decoding	63
10.6.1 Dragging Channels to the Video Wall.....	63
10.6.2 Opening Window for Non-LED Screen	64
10.6.3 Opening Window for LED Screen	64
10.6.4 Managing Decoding	65

10.6.5 Configuring Auto-Switch Decoding	66
10.6.6 PTZ Control	67
10.6.7 Playback.....	67
10.6.8 Configuring Scene	69
10.6.9 Configuring Window	70
10.7 Decoding Thermal Network Camera	71
10.7.1 Configuring the Thermal Network Camera Parameters.....	71
10.7.2 Decoding Thermal Network Camera on the Video Wall	79
10.8 Controlling Remote Screen.....	80
10.8.1 Configuring the RSC Server.....	81
10.8.2 Controlling Remote Screen via RSC Server	82
10.9 Remote Configuration	85
10.9.1 Configuring Ethernet Channel	85
10.10 Stream Media Server Configuration	86
10.10.1 Installing Stream Media Server.....	86
10.10.2 Running Stream Media Server	87
10.10.3 Adding Stream Media Server.....	87
10.10.4 Configuring Stream Media Server.....	88
Chapter 11 Appendix.....	94
11.1 Specifications.....	94
11.2 FAQ.....	98
11.3 List of Third-Party IP Cameras Access	99

Chapter 1 Introduction

1.1 Description

Designed for the high-definition video monitoring system, DS-6900UDI Decoder is developed on the basis of embedded hardware platform, ensuring high reliability and stability of system running.

DS-6900UDI Decoder is capable of simultaneous decoding video for 8-ch@24MP, 16-ch@12MP, 32-ch@8MP, 48-ch@5MP, 80-ch@3MP, 128-ch@1080p simultaneous decoding, and outputting decoded video via BNC, VGA, or HDMI interfaces, and it also supports multiple video stream formats like H.265, H.264+, Hik264, H.264 and MPEG4. The decoded video can be displayed on video wall or large screen.

1.2 Features

Powerful Decoding Capability

- DS-6901UDI provides HDMI, VGA, and BNC output interfaces.
- Up to 8-ch decoding at 24 MP resolution (DS-6916UDI).
- DS-6904UDI, DS-6908UDI, DS-6910UDI, DS-6912UDI, DS-6916UDI provide HDMI (adaptable to DVI-D) and BNC output interfaces.
- Up to 4K (3840 × 2160@30 Hz) via HDMI interface (only for even interface), and up to 1080p@60Hz via VGA interface.
- H.265+/H.265, H.264+/Hik264/H.264, MPEG4 and MJPEG video stream formats.
- PS, RTP, TS, ES, HIK encapsulation formats.
- Supports window opening and window roaming.
- Supports two-window division mode.
- You can double click the roaming window to zoom in or out for one roaming window or divided roaming sub-window.
- Three encoding levels: baseline, main, and high-profile.
- G.722, G711A, G726, G711U, MPEG2-L2, and AAC audio stream formats.
- Accessible by panoVu network camera.
- Accessible by 2.4 MP DeepinView camera.
- Accessible by thermal network camera and you can view the temperature measurement, dynamic fire source detection, ship detection and VCA information in live view and playback.
- You can enable or disable the smart information for the thermal network camera.

Multiple Decoding Control Modes

- Two decoding modes: active decoding and passive decoding.
- Decoding output of remote video files.
- Decoding on video wall by directly linking cameras or by stream media forwarding.
- Gets stream and decodes via URL.
- Remotely controls PTZ of DVR or DVS via transparent channel.
- Two-way audio via client software.
- Supports multi-screen control with PC installed with RSC server.
- Configurable LED width and height parameters when the LED is connected.
- Regular and irregular virtual screen configurable to display multiple signal sources and get rid of the restriction of physical screen.
- LCD output type configurable for the BNC and VGA outputs; LCD and LED output types configurable for HDMI outputs.
- You can configure what the video wall show when decoding ends and streaming fails via the Web browser and client software.
- Auto-switch of sub-stream configurable via the Web browser and client software.

Integrated Capability

- Decoding video/audio stream accessed by ONIVF, RTP/RTSP protocols.
- Provides complete software development kit (SDK) for third-party developers.
- Port link aggregation technology (Ethernet Channel).

Maintenance Management

- Remotely get, configure, export and import parameters.
- Remotely reboot, restore default settings and upgrading via web browser or client software.

Chapter 2 Panels and Connections

2.1 Front Panel

- Front panel of DS-6901UDI

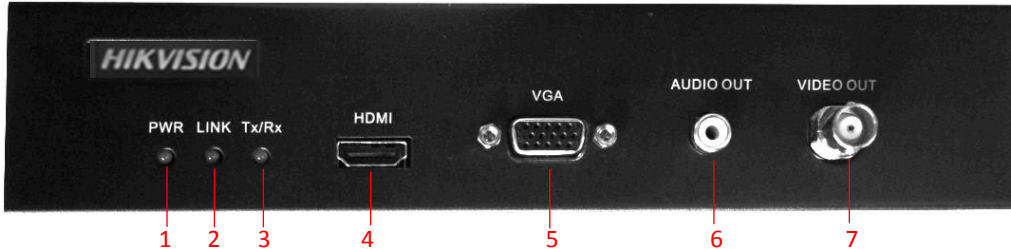

Figure 2-1 Front Panel of DS-6901UDI

Table 2-1 Description of DS-6901UDI Front Panel

No.	LED Indicator & Interface	Description
1	POWER	Power indicator
2	LINK	Network connection indicator
3	Tx/Rx	Data transmitting/receiving status indicator
4	HDMI video output	HDMI output for decoded video
5	VGA video output	VGA output of decoded video
6	Audio output	Audio output, 3.5mm connector
7	Video output	Video output, BNC connector

- Front Panel of DS-6904/6908UDI

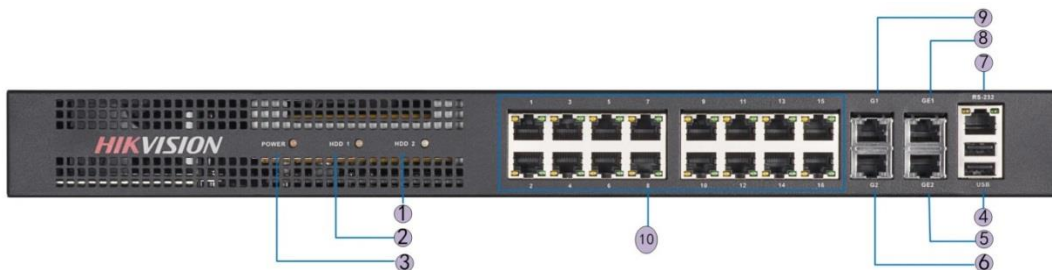

Figure 2-2 Front Panel of DS-6904/6908UDI

Table 2-2 Description of DS-6904/6908UDI Front Panel

	LED Indicator & Interface	Connections
1	Power	Power indicator
2	HDD1	Hard disk 1 indicator (Reserved)
3	HDD2	Hard disk 2 indicator (Reserved)
4	USB	USB 2.0 interface
5	GE2	Local management network interface 2
6	G2	10/100/1000 Mbps Ethernet interface 2
7	RS-232 serial interface	Connect to RS-232 devices, e.g., PC etc.
8	GE1	Local management network interface
9	G1	10/100/1000 Mbps Ethernet interface
10	LAN	LAN 10/100 Mbps Ethernet interface

 **NOTE**

DS-6904UDI provides 4-ch HDMI output interfaces and other interfaces are the same with DS-6908UDI.

● Front Panel of DS-6910/6912/6916UDI

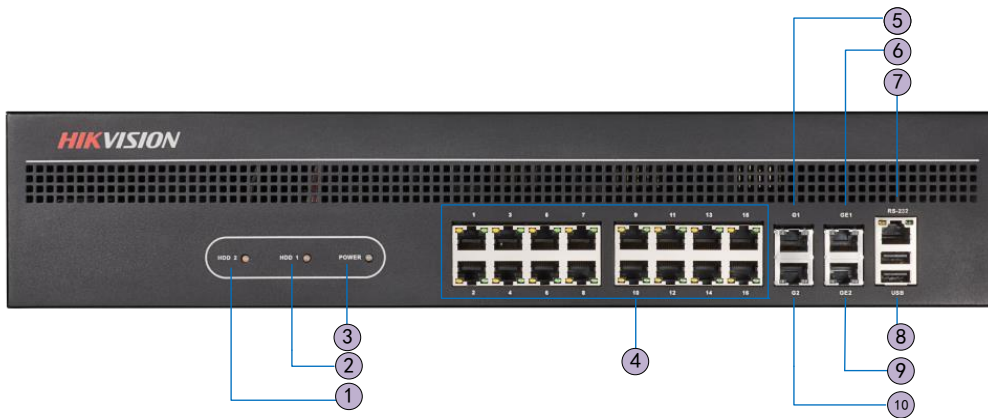

Figure 2-3 Front Panel of DS-6916UDI

Table 2-3 Description of DS-6916UDI Front Panel

	LED Indicator & Interface	Connections
1	HDD1	Hard disk 1 indicator (Reserved)
2	HDD2	Hard disk 2 indicator (Reserved)
3	POWER	Power indicator
4	LAN	10/100 Mbps Ethernet interface
5	G1	10/100/1000 Mbps Ethernet interface
6	GE1	Local management network interface
7	RS-232 serial interface	Connect to RS-232 devices, e.g., PC etc.
8	USB	USB 2.0 interface
9	GE2	Local management network interface 2
10	G2	10/100/1000 Mbps Ethernet interface 2

2.2 Rear Panel

- Rear Panel of DS-6901UDI

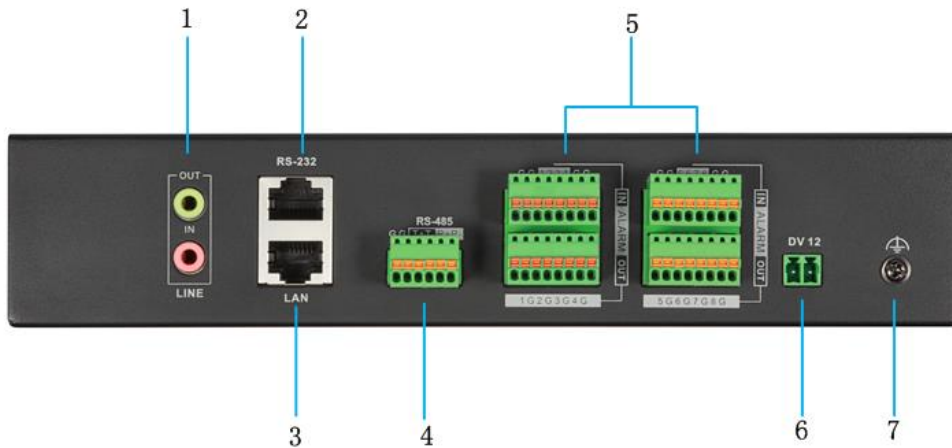



Figure 2-4 Rear Panel of DS-6901UDI

Table 2-5 Description of DS-6901UDI Rear Panel

	Interface	Connections
1	LINE IN/OUT	Two-way audio input/output, 3.5 mm connector
2	RS-232 serial interface	Connect to RS-232 devices, e.g., PC.
3	LAN	10/100/1000 Mbps Ethernet interface

4	RS-485 serial interface	Connect to RS-485 devices, e.g., keyboard.
5	Alarm in	8 alarm inputs
	Alarm out	8 alarm outputs
6	Power supply	12 VDC power input
7		GND

● Rear Panel of DS-6908UDI

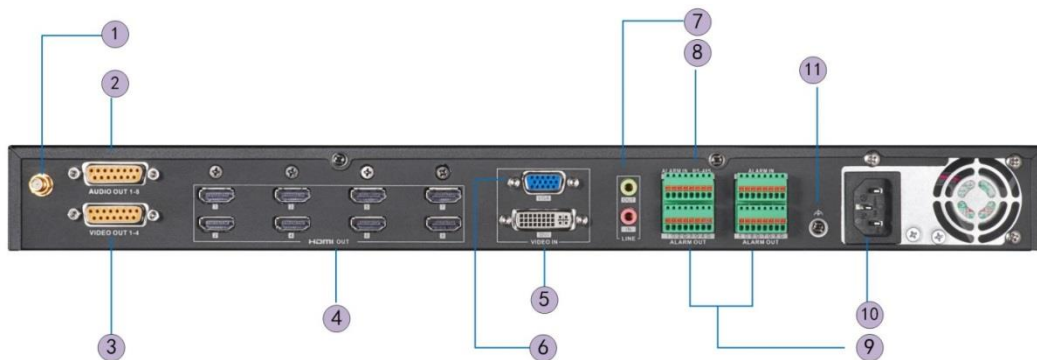



Figure 2-5 Rear Panel of DS-6908UDI

Table 2-6 Description of DS-6908UDI

	Interface	Connections
1	Wi-Fi	For Wi-Fi connection
2	Audio output	BNC connector
3	Video output	BNC connector
4	HDMI video output	HDMI output of decoded video
5	DVI video input	DVI input of decoded video
6	VGA video input	VGA input of decoded video
7	LINE IN/OUT	Two-way audio input/output, 3.5mm connector
8	RS-485 serial interface	Connect to RS-485 devices, e.g., keyboard.
9	Alarm in	8 alarm inputs
	Alarm out	8 alarm outputs
10	Power	Power indicator
11		GND

● Rear Panel of DS-6916UDI

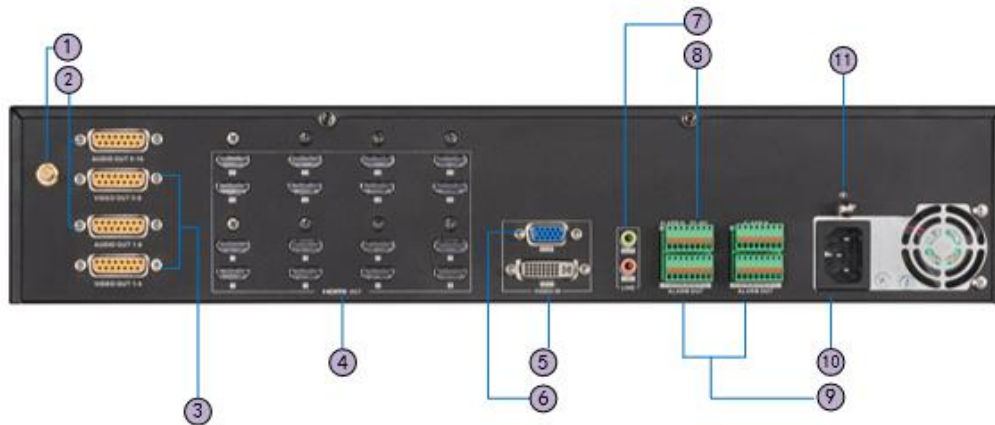



Figure 2-6 Rear Panel of DS-6916UDI

Table 2-7 Description of DS-6916UDI Rear Panel

	Interface	Connections
1	Wi-Fi	For Wi-Fi connection
2	Audio output	BNC connector
3	Video output	BNC connector
4	HDMI video output	HDMI output of decoded video
5	DVI video input	DVI input of decoded video
6	VGA video input	VGA input of decoded video
7	LINE IN/OUT	Two-way audio input/output, 3.5mm connector
8	RS-485 serial interface	Connect to RS-485 devices, e.g., keyboard, etc.
9	Alarm in	8 alarm inputs
	Alarm out	8 alarm outputs
10	Power	Power indicator
11		GND

 **NOTE**

DS-6910UDI provides 10 HDMI output interfaces, DS-6912UDI provides 12 HDMI output interfaces and other interfaces are the same with DS-6916UDI.

Chapter 3 Device Activation

Purpose

You are required to activate the decoder first by setting a strong password for it before you can use the device. And you can configure the basic network parameters.

Activation via Web Browser and Client Software are all supported.



For the first-time user, the default user name of DS-6900UDI is *admin*, and the default IP address is 192.0.0.64.

3.1 Activating via SADP Software

SADP software is used for detecting the online device, activating the camera, and resetting the password.

Get the SADP software from the supplied disk or the official website, and install the SADP according to the prompts. Follow the steps to activate the camera.

Step 1 Run the SADP software to search the online devices.

Step 2 Check the device status from the device list, and select the inactive device.

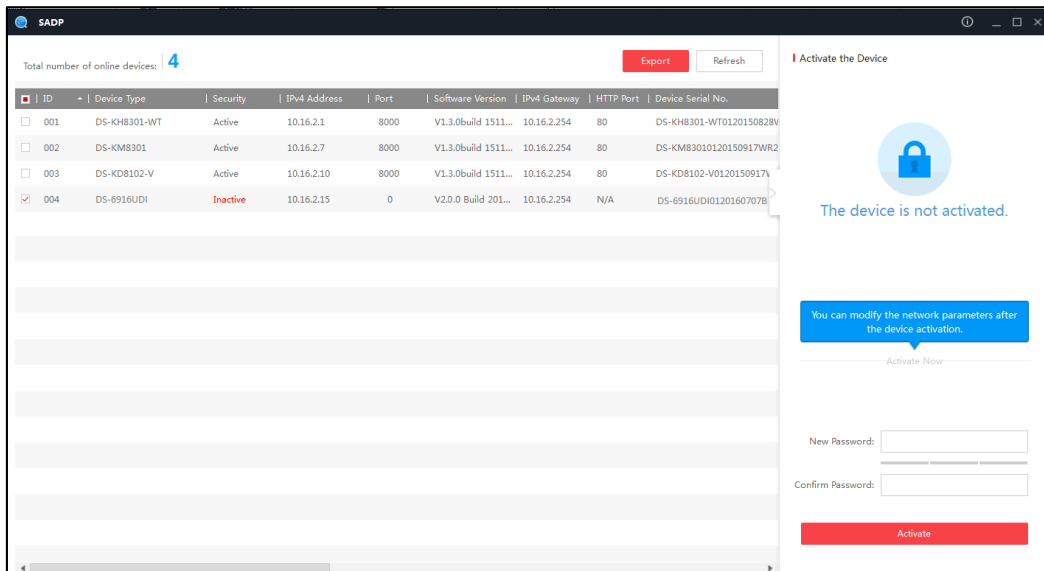

Figure 3-1 SADP Interface

Step 3 Create a password and input it in the password field, and confirm the password.

Step 4 Click **Activate** to activate the device.

**WARNING**

STRONG PASSWORD RECOMMENDED—We highly recommend you create a strong password of your own choosing (Using a minimum of 8 characters, including at least three of the following categories: upper case letters, lower case letters, numbers, and special characters.) in order to increase the security of your product. And we recommend you reset your password regularly, especially in the high security system, resetting the password monthly or weekly can better protect your product.

Step 5 Change the device IP address to the same subnet with your computer by either modifying the IP address manually or checking the checkbox of Enable DHCP.

Modify Network Parameters

Enable DHCP

Device Serial No.: DS-6916UDI0120160707BBRR25

IP Address: 10.16.2.15

Port: 0

Subnet Mask: 255.255.255.0

Gateway: 10.16.2.254

IPv6 Address:

IPv6 Gateway:

IPv6 Prefix Length: 0

HTTP Port: 0

Security Verification

Admin Password: ●●●●●●●

Modify

[Forgot Password](#)

Figure 3-2 Modify the IP Address

Step 6 Input the password and click the **Modify** button to activate your IP address modification.

3.2 Activating via Web Browser

Step 1 Power on the decoder, and connect the decoder to the network.

Step 2 Input the IP address into the address bar of the web browser, and click Enter to enter the activation interface.

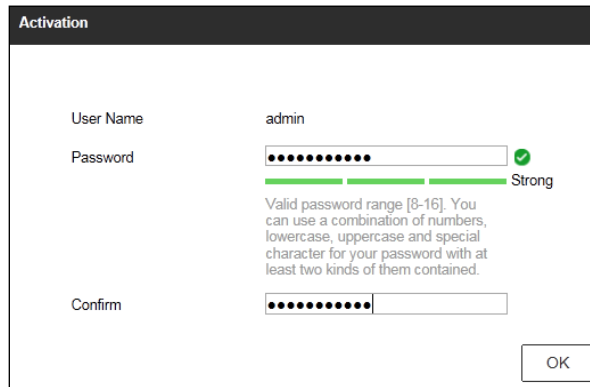

The screenshot shows a web-based 'Activation' form. It has three input fields: 'User Name' with the value 'admin', 'Password' with a masked password and a green checkmark and 'Strong' label, and 'Confirm' with a masked password. Below the password field is a green progress bar and a text box explaining the password requirements: 'Valid password range [8-16]. You can use a combination of numbers, lowercase, uppercase and special character for your password with at least two kinds of them contained.' An 'OK' button is located at the bottom right of the form.

Figure 3-3 Activation Interface

Step 3 Create a password and input the password into the password field.



STRONG PASSWORD RECOMMENDED—We highly recommend you create a strong password of your own choosing (Using a minimum of 8 characters, including at least three of the following categories: upper case letters, lower case letters, numbers, and special characters.) in order to increase the security of your product. And we recommend you reset your password regularly, especially in the high security system, resetting the password monthly or weekly can better protect your product.

Step 4 Confirm the password.

Step 5 Click **OK** to save the password and enter the live view interface.

3.3 Activating via Client Software

The client software is versatile video management software for multiple kinds of devices.

Get the client software from the supplied disk or the official website, and install the software according to the prompts. Follow the steps to activate the camera.

Step 1 Run the client software.

Step 2 Click the **Device Management** icon to enter the Device Management interface, as shown in the figure below.

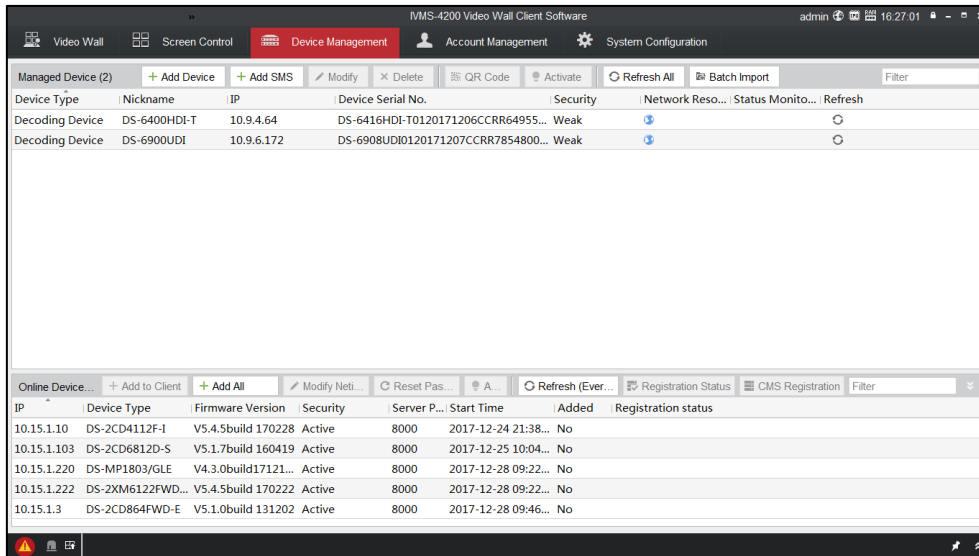

Figure 3-4 Device Management

Step 3 Check the device status from the device list, and select an inactive device.

Step 4 Click the **Activate** button to pop up the Activation interface.

Step 5 Create a password and input the password in the password field, and confirm the password.



WARNING

STRONG PASSWORD RECOMMENDED—We highly recommend you create a strong password of your own choosing (Using a minimum of 8 characters, including at least three of the following categories: upper case letters, lower case letters, numbers, and special characters.) in order to increase the security of your product. And we recommend you reset your password regularly, especially in the high security system, resetting the password monthly or weekly can better protect your product.

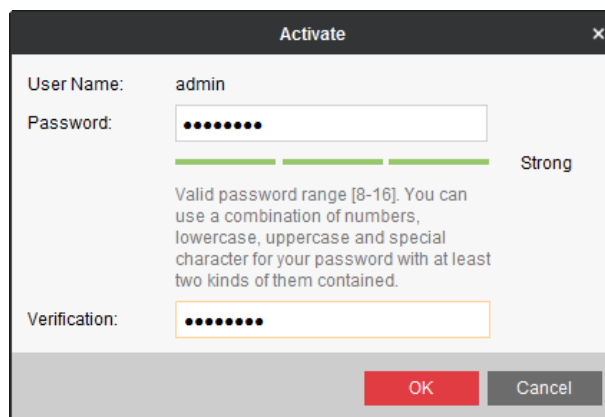

Figure 3-5 Activation Interface (Client Software)

Step 6 Click **OK** button to start activation.

Step 7 Click the **Modify Netinfo** button to pop up the Network Parameter Modification interface, as shown in the figure below.

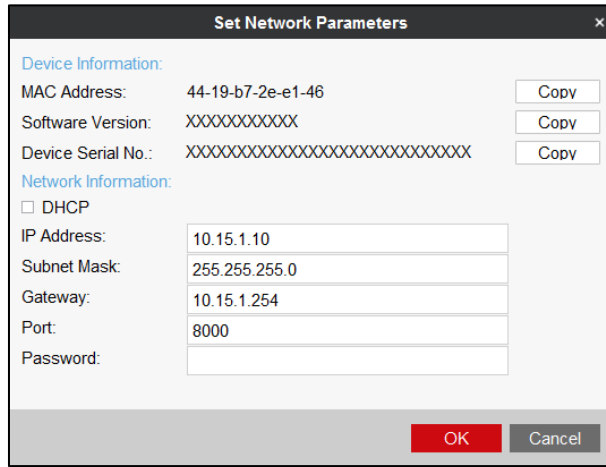

Figure 3-6 Modify the Network Parameters

Step 8 Change the device IP address to the same subnet with your computer by either modifying the IP address manually or checking the **DHCP** checkbox.

Step 9 Input the password to activate your IP address modification.

Chapter 4 Network Configuration

NOTE

You shall acknowledge that the use of the product with the Internet access might be under network security risks. For avoidance of any network attacks and information leakage, please strengthen your own protection. If the product does not work properly, contact with your dealer or the nearest service center.

Purpose

You shall configure the basic network, and DDNS settings before other operations. In this chapter, the network configuration of the decoder by the Web browser is provided.

NOTE

The tested Web browsers include: IE 8.0+, Chrome 18.0+, Firefox 5.0+, and Safari 5.02+.

Step 1 Open the Web browser and input the IP address of Decoder (e.g., <http://192.168.0.0>).

Step 2 Log in to the device.

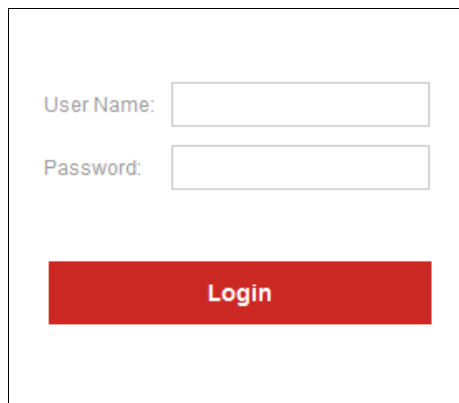

The login interface consists of a white rectangular box. Inside, there are two input fields: 'User Name:' followed by a text box, and 'Password:' followed by a text box. Below these fields is a prominent red rectangular button with the word 'Login' written in white text.

Figure 4-1 Login Interface

- If the device has not been activated, you need to activate the device first before login.

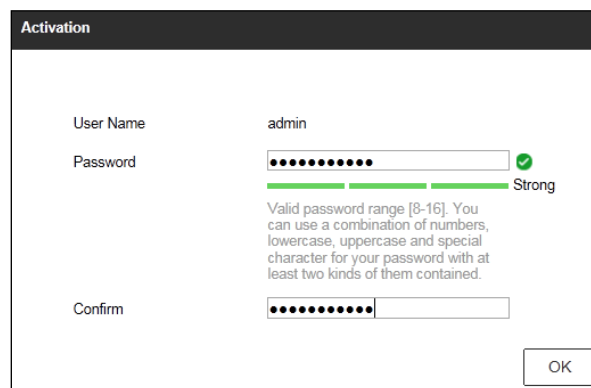

The activation interface is titled 'Activation' in a dark header. It contains three input fields: 'User Name' with the value 'admin', 'Password' with a masked field (dots) and a green checkmark icon, and 'Confirm' with a masked field (dots). Below the password field is a green progress bar and the text 'Strong'. A detailed password requirement note is displayed: 'Valid password range [8-16]. You can use a combination of numbers, lowercase, uppercase and special character for your password with at least two kinds of them contained.' An 'OK' button is located in the bottom right corner.

Figure 4-2 Activation Interface

**WARNING**

STRONG PASSWORD RECOMMENDED—We highly recommend you create a strong password of your own choosing (Using a minimum of 8 characters, including at least three of the following categories: upper case letters, lower case letters, numbers, and special characters.) in order to increase the security of your product. And we recommend you reset your password regularly, especially in the high security system, resetting the password monthly or weekly can better protect your product.

- If the device is already activated, input the user name and password in the login interface, and click the **Login** button.

The following interface is shown after successful login.

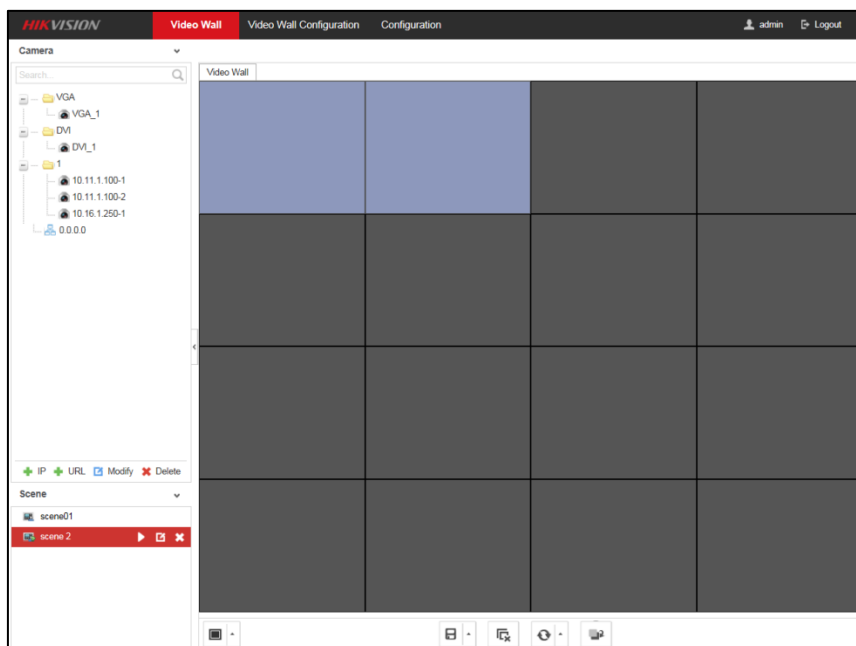

Figure 4-3 Enter Web Page

4.1 Configuring Basic Network Settings

Purpose

You can set the network parameters for the decoder in the parameter configuration interface.

Step 1 Click **Configuration** > **Network** > **TCP/IP** to enter the general network settings interface.

TCP/IP	DDNS	Wi-Fi
Select NIC	GE1	
IPv4 Address	10.66.72.188	
IPv4 Subnet Mask	255.255.255.0	
IPv4 Gateway	10.66.72.254	
Preferred DNS Server	0.0.0.0	
Alternate DNS Server	0.0.0.0	

 Save

Figure 4-4 Configure Basic Network Settings

Step 2 Set the network parameters, including the NIC, IP Address, Subnet Mask, Gateway, and DNS Server.

 **NOTE**

The DS-6904/6908/6910/6912/6916UDI provides multiple NICs for selection.

Step 3 Click **Save** to save the settings.

4.2 Configuring DDNS Settings

Purpose

If your device is set to use PPPoE as its default network connection, you may set Dynamic DNS (DDNS) to be used for network access.

Prior registration with your DDNS Provider is required before configuring the system to use DDNS.

Step 1 Click **Configuration** > **Network** > **DDNS** to enter the DDNS Settings interface.

Step 2 Check the **Enable DDNS** checkbox to enable this function.

Step 3 Select **DDNS Type**. Four different DDNS types are selectable: IPServer, DynDNS, PeanutHull, and NO-IP.

- **DynDNS**

1. Enter **Server Address** for DynDNS (e.g., members.dyndns.org).
2. Enter the **User Name** and **Password** registered in the DynDNS website.
3. In the **Domain** text field, enter the domain obtained from the DynDNS website.
4. Click **Save** to save the settings.

The screenshot shows the DDNS configuration interface. At the top, there are three tabs: 'TCP/IP', 'DDNS' (which is selected and highlighted in red), and 'Wi-Fi'. Below the tabs, there is a checkbox labeled 'Enable DDNS' which is checked. Underneath, there is a dropdown menu for 'DDNS Type' set to 'DynDNS'. Below that are several input fields: 'Server Address' with the value 'members.dyndns.org', 'Port' with '2', 'Domain' with 'test.dyndns.com', 'User Name' with 'test', 'Password' (masked with dots), and 'Confirm' (also masked with dots). Each of these input fields has a green checkmark to its right, indicating they are valid. At the bottom of the form is a red button with a white floppy disk icon and the text 'Save'.

Figure 4-5 DynDNS Settings

● IPServer

1. Enter server address for IPServer.
2. Click **Save** to save the settings.

 **NOTE**

For the IP Server, you have to apply a static IP, subnet mask, gateway and primary DNS from the ISP. The **Server Address** should be entered with the static IP address of the PC that runs IP Server software.

The screenshot shows the DDNS configuration interface with 'IPServer' selected. The 'DDNS Type' dropdown is set to 'IPServer'. The 'Server Address' field contains '210.11.3.45' and has a green checkmark. The other fields ('Port', 'Domain', 'User Name', 'Password', 'Confirm') are empty. A red 'Save' button is at the bottom.

Figure 4-6 IPServer Settings

● PeanutHull

1. Enter User Name and Password obtained from the PeanutHull website.
2. Click **Save** to save the settings.

The screenshot shows the DDNS configuration interface. At the top, there are three tabs: 'TCP/IP', 'DDNS' (which is selected and highlighted in red), and 'Wi-Fi'. Below the tabs, there is a checkbox labeled 'Enable DDNS' which is checked. Underneath, there is a dropdown menu for 'DDNS Type' set to 'PeanutHull'. Below that are input fields for 'Server Address', 'Port', 'Domain', 'User Name', 'Password', and 'Confirm'. The 'Domain' field has a green checkmark to its right. The 'User Name' field contains the text 'test.gicp.net' and has a green checkmark. The 'Password' and 'Confirm' fields are filled with dots and each has a green checkmark. At the bottom of the form is a red button with a white floppy disk icon and the text 'Save'.

Figure 4-7 PeanutHull Settings

- NO-IP

1. Enter **Server Address** for NO-IP.
2. In the **Domain** text field, enter the domain obtained from the NO-IP website (www.no-ip.com).
3. Enter the **User Name** and **Password** registered in the NO-IP website.
4. Confirm the password.
5. Click **Save** to save the settings.

The screenshot shows the DDNS configuration interface for NO-IP. At the top, there are three tabs: 'TCP/IP', 'DDNS' (which is selected and highlighted in red), and 'Wi-Fi'. Below the tabs, there is a checkbox labeled 'Enable DDNS' which is checked. Underneath, there is a dropdown menu for 'DDNS Type' set to 'NO-IP'. Below that are input fields for 'Server Address', 'Port', 'Domain', 'User Name', 'Password', and 'Confirm'. At the bottom of the form is a red button with a white floppy disk icon and the text 'Save'.

Figure 4-8 NO-IP Settings

4.3 Configuring Security Control

Purpose

You can disable SSH, SADP, or HTTPS to enhance the access security, e.g., when you are in the untrusted network environment.

Step 1 Go to **Configuration > Security Control**.

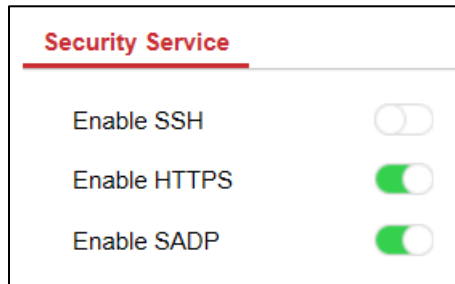

Figure 4-9 Security Service

Step 2 Uncheck **Enable SSH**, **Enable SADP**, or **Enable HTTPS** to disable the services.

 **NOTE**

- By default, SSH is disabled, and SADP and HTTPS are enabled.
- The login user name for SSH is *root*, and the password is the same with that of the admin.

Chapter 5 Decoding Parameters Configuration

5.1 Configuring Stream Settings

Purpose

The stream configuration refers to the auto stream switch between main stream and sub-stream.

Step 1 Click **Configuration** > **Decoding Configuration** > **Stream Configuration** to enter stream configuration interface.

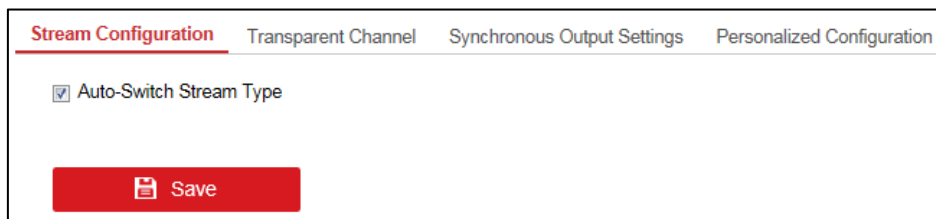

Figure 5-1 Stream Configuration Interface

Step 2 Check the check box of **Auto-Switch Stream Type** to enable auto switch between main stream and sub-stream.

Step 3 Click **Save** button to save the settings.



NOTE

When a screen is split into more than 16 windows, the main stream will automatically switch to sub-stream to lower the bandwidth.

5.2 Configuring Transparent Channel

Purpose

The Transparent Channel refers to the transmission channel used for forwarding data between the decoder and the encoder without operating on the data.

Step 1 Click **Configuration** > **Decoding Configuration** > **Transparent Channel** to enter transparent channel settings interface.

No.	Local Serial Port	Remote Serial Port	IP Address	Port	Connection Status
1	RS-232		0.0.0.0	0	Not connected
2	RS-232		0.0.0.0	0	Not connected
3	RS-232		0.0.0.0	0	Not connected
4	RS-232		0.0.0.0	0	Not connected
5	RS-232		0.0.0.0	0	Not connected
6	RS-232		0.0.0.0	0	Not connected
7	RS-232		0.0.0.0	0	Not connected
8	RS-232		0.0.0.0	0	Not connected
9	RS-232		0.0.0.0	0	Not connected
10	RS-232		0.0.0.0	0	Not connected
11	RS-232		0.0.0.0	0	Not connected
12	RS-232		0.0.0.0	0	Not connected
13	RS-232		0.0.0.0	0	Not connected

Figure 5-2 Transparent Channel Interface

Step 2 Select a transparent channel from the list to configure.

Step 3 Click **Modify** to modify the parameters of the selected transparent channel.

Figure 5-3 Modifying Interface

Step 4 Select the **Local Serial Port** and the **Remote Serial Port** to RS-485 or RS-232.

Local Serial Port: The serial port used as the transparent channel by the decoder.

Remote Serial Port: The serial port used as the transparent channel by the encoding device.



You can click **Delete** to delete the selected channel.

5.3 Configuring Synchronous Output Settings

Purpose

All video outputs of the device can be configured to be synchronous.

Step 1 Click **Configuration** > **Decoding Configuration** > **Synchronous Output Settings** to enter the Synchronous Output Settings interface.

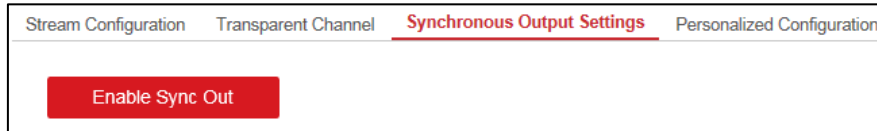

Figure 5-4 Synchronous Output Settings

Step 2 Click the **Enable Sync Out** button to enable the synchronization of all outputs. The following message box pops up.

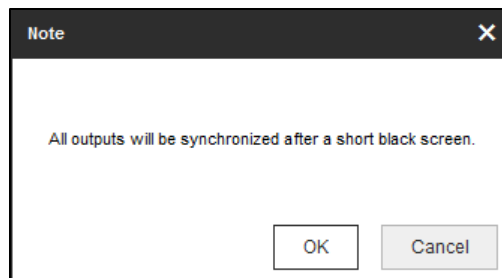

Figure 5-5 Enable Synchronous Output

Step 3 Click **OK** to confirm the settings.

5.4 Configuring Personalized Settings

Purpose

You can set the stopped decoding image and failed streaming image for the personalized configuration.

Step 1 Click **Configuration** > **Decoding Configuration** > **Personalized Configuration** to enter the personalized configuration interface.

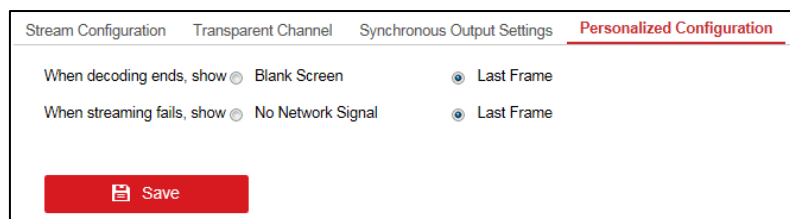

Figure 5-6 Personalized Configuration

Step 2 Select **Blank Screen** or **Last Frame** when decoding ends. If you select **Blank Screen**, the screen will change blank when the decoding ends. If you select **Last Frame**, the screen will show the last frame when the decoding ends.

Step 3 Select **No Network Signal** or **Last Frame** when streaming fails. If you select **No Network Signal**, the screen will show the cause of the failure when streaming fails. If you select **Last Frame**, the screen will show the last frame when streaming fails.

Step 4 Click **Save** to save the settings.

Chapter 6 Decoding Operation

6.1 Configuring Encoding Devices

6.1.1 Adding an Encoding Device

Purpose

You can add an encoding device via IP address or URL.

● **Adding an Encoding Device via IP Address**

Step 1 Click **IP** to add encoding devices.

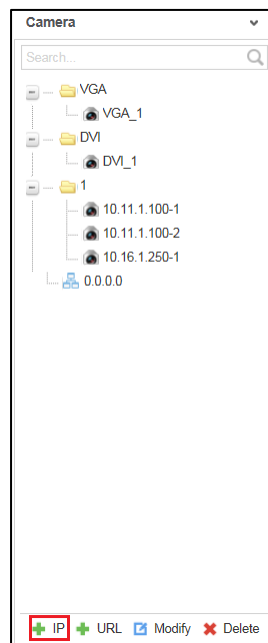

Figure 6-1 Encoding Device List

Step 2 Input **Device Name**, **Type**, **Port**, **User Name**, **Password** and **Channel Number** and select the **Transmission Protocol**, **Area Name**, and **Device Manufacturer**. Decide whether to enable **Stream Encryption** and input the encryption password. Check the checkbox of **Get Stream by Stream Media** to lower the network load of the device.

NOTE

- You can add device by IP or DDNS. If you select DDNS, you need to enter the domain name and ensure that you have configured the DNS server. For details, see section 4.1 Configuring Basic Network Settings.
- If **Stream Encryption** is enabled, you need to input the encryption password so you can remotely watch live videos of encrypted camera streams.

The screenshot shows a dialog box titled "Add" with a close button (X) in the top right corner. The dialog contains the following fields and controls:

- type**: A dropdown menu set to "IP" with a green checkmark to its right.
- IP Address**: An empty text input field.
- Port**: An empty text input field.
- User Name**: An empty text input field.
- Password**: An empty text input field.
- Transmission Protocol**: A dropdown menu set to "TCP".
- Stream Type**: A dropdown menu set to "Main Stream".
- Stream encryption**: A toggle switch that is currently turned off.
- The secret key**: A greyed-out text input field.
- Area Name**: A dropdown menu set to "1" with a green plus sign to its right.
- Device Manufacturer**: A dropdown menu set to "HIKVISION".
- Channel Number**: An empty text input field.
- Get Stream by Streammedia**
- Streammedia IP Address**: A greyed-out text input field.
- Port**: A greyed-out text input field.
- Transmission Protocol**: A dropdown menu set to "TCP".

At the bottom of the dialog, there are two buttons: "Next" and "Cancel".

Figure 6-2 Add Device via IP Address

Step 3 (Optional) You can also click **+** to add a new area and click **Save** to save the area.

Step 4 Click **Next** to select the channel. The channel(s) displayed here depend(s) on the **Channel Number** you input on the previous page.

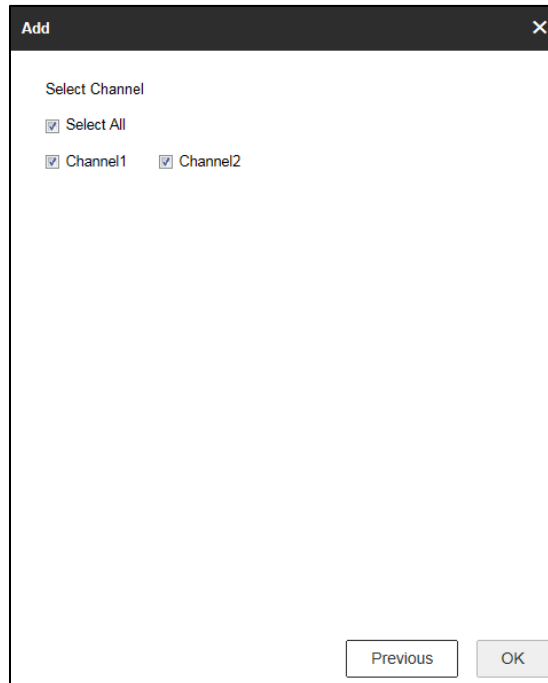

Figure 6-3 Select the Channel

Step 5 Click **OK** to save the settings and add the device.

● **Adding an Encoding Device via URL**

Step 1 Click **URL** to add encoding devices.

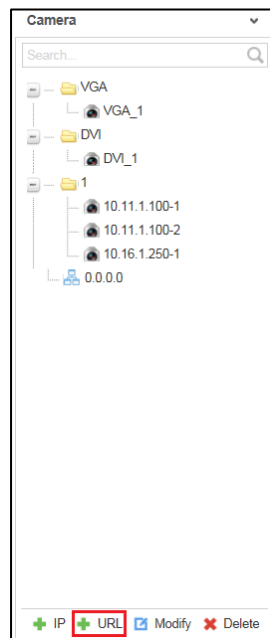

Figure 6-4 Encoding Device List

Step 2 Input the **Device Name** and **URL**. Select the **Area Name** from the dropdown list or click **+** to add a new area. Decide whether to enable **Stream Encryption** and input the encryption password.

 **NOTE**

- An example of the URL format is as follows:
rtsp://10.9.1.233:554/h264/ch1/main/av_stream/?username=admin?password=hik12345?linkmode=tcp
In the above URL, **10.9.1.233** indicates the device IP, **admin** indicates the user name, **hik12345** indicates the password, and **tcp** indicates the stream transport protocol. The transport protocol can be set as tcp, udp, and mcast.
- If **Stream Encryption** is enabled, you need to input the encryption password so you can remotely watch live videos of encrypted camera streams.

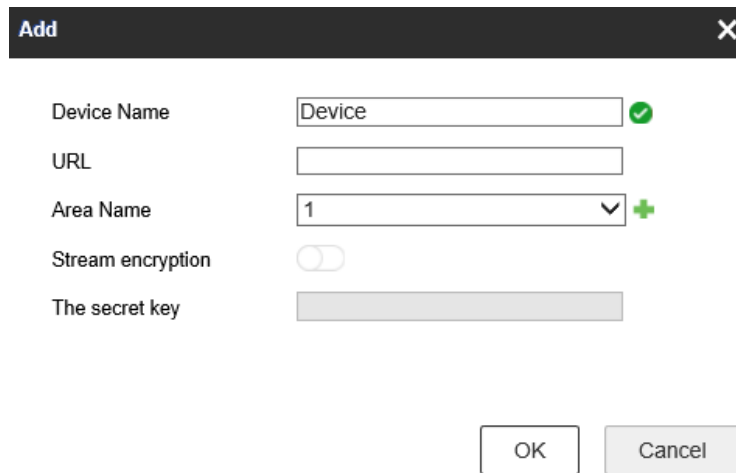

Figure 6-5 Add Device via URL

Step 3 Click **OK** to save the settings.

6.1.2 Modifying an Encoding Device

Step 1 Select one area or one encoding device, and click **Modify** to modify corresponding parameters.

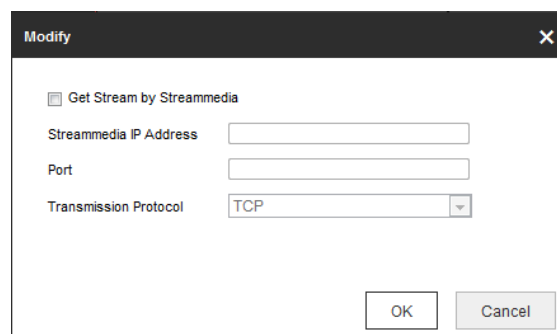

Figure 6-6 Modify Area

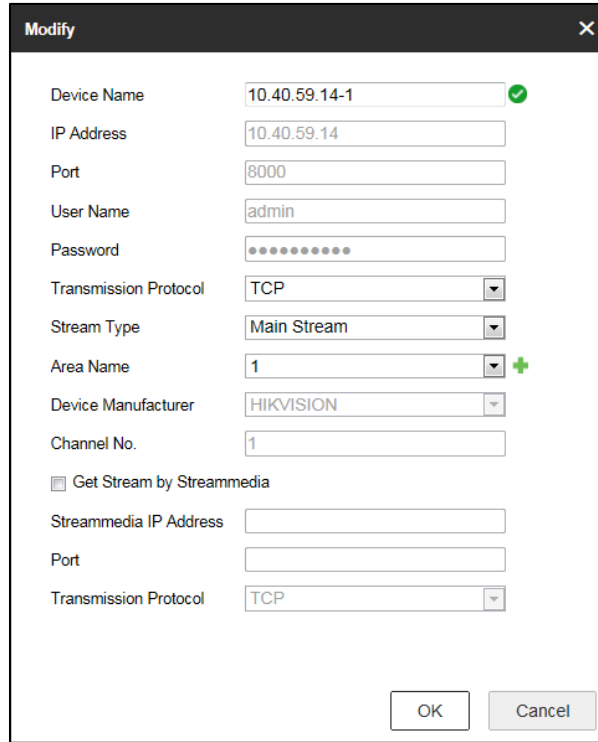

Figure 6-7 Modify Encoding Device

Step 2 Click **OK** to save the new settings.

6.1.3 Deleting an Encoding Device

Step 1 Select one area or one encoding device and click **Delete** to pop up the note interface below.

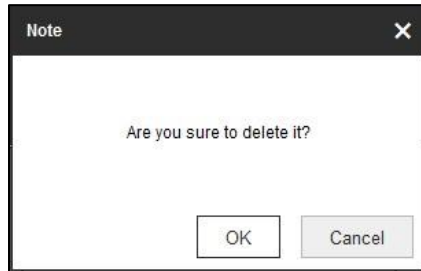

Figure 6-8 Deleting Note

Step 2 Click **OK** to delete it.

6.2 Configuring Video Wall

Purpose

To realize the display of the decoded video on the video wall, you must set the video wall configuration first so as to link the video output with video wall.

Step 1 Click **Video Wall Configuration** to enter the corresponding interface.

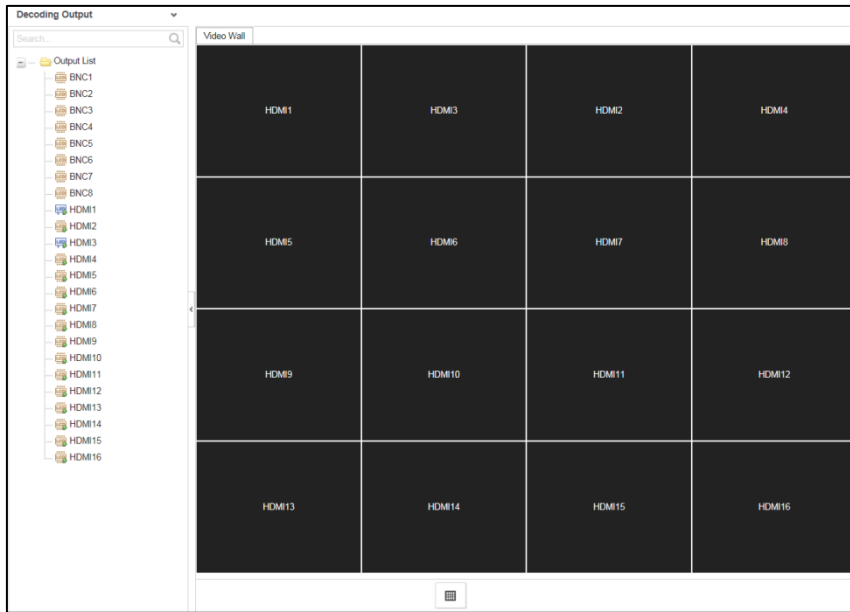



Figure 6-9 Video Wall Configuration

Step 2 You can use the default video wall layout or click  to add a new layout. Input the number of screens in row and column and up to 16 × 20 split screens are available.

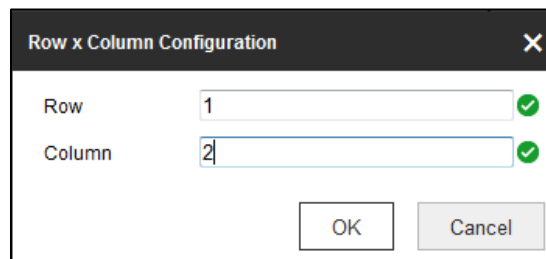



Figure 6-10 Screen Layout Configuration

Step 3 Click **OK** to finish the adding of the video wall information.

Step 4 Drag the output channels from the left-side list to the display screen.

Step 5 Move the cursor to the window, and the icon  automatically appears in the upper-right corner of the window. Click  to close the window.

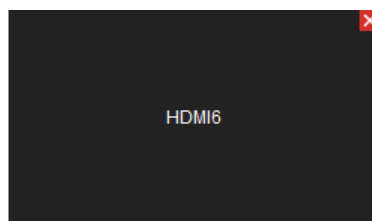

Figure 6-11 Close the Window

6.3 Configuring Decoding Output

Purpose

In the output list, there are two kinds of video output signals, respectively BNC and HDMI. You can configure the resolution and output mode.

6.3.1 Configuring BNC Output

Step 1 Click **Video Wall Configuration** to enter the corresponding interface. Right click one of the BNC signal sources.

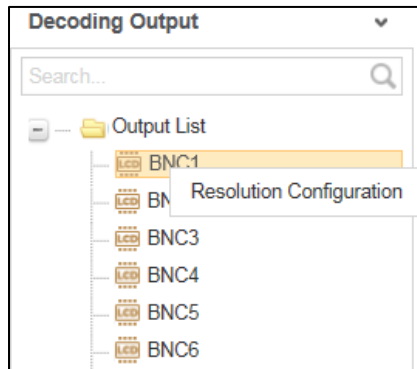

Figure 6-12 BNC Decoding Output

Step 2 Right click one of BNC signal sources and select **Resolution Configuration** to pop up the interface as below.

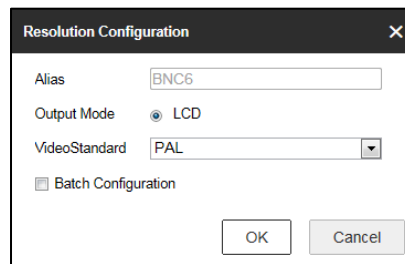

Figure 6-13 Resolution Configuration

Step 3 Select the resolution from the **LCD Resolution** drop-down list. PAL and NTSC are selectable.

Step 4 Check the checkbox of **Batch Configuration** to set the same configuration for other outputs with same signal source.

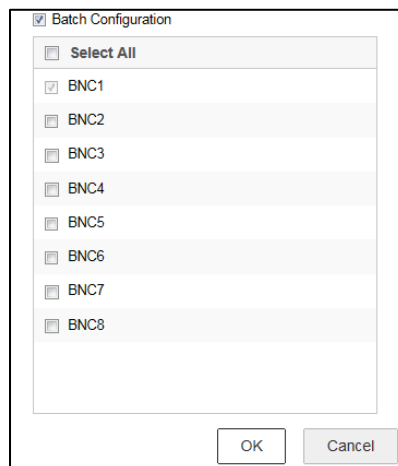

Figure 6-14 Batch Configuration

Step 5 Click **OK** to save the settings.

6.3.2 Configuring HDMI Output

Step 1 Right click one of the HDMI signal sources.

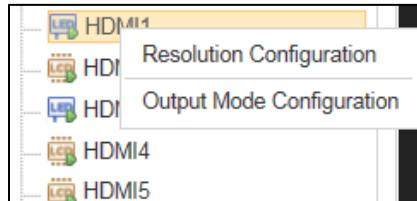

Figure 6-15 HDMI Decoding Output

Step 2 Click **Resolution Configuration** to enter the interface below.

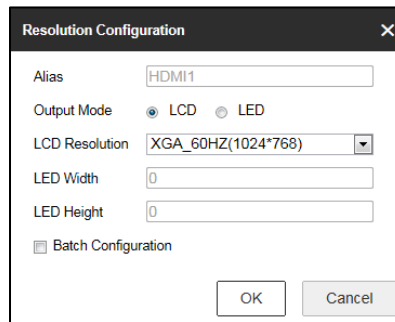

Figure 6-16 Resolution Configuration

Step 3 Select the **Output Mode** and set the corresponding parameters. You can select LCD and LED.

● LCD

1. Select the **Output Mode** to LCD.
1. Select the resolution from the **LCD Resolution** drop-down list.

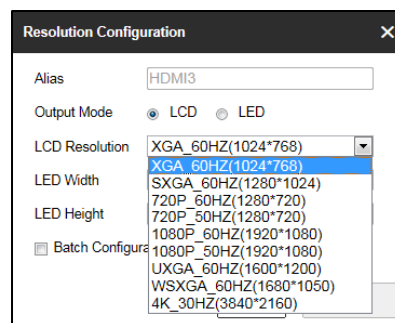

Figure 6-17 Set LCD Resolution

● LED

1. Select the **Output Mode** to LED.
1. Input the **LED Width** and **LED Height** in the corresponding text fields.

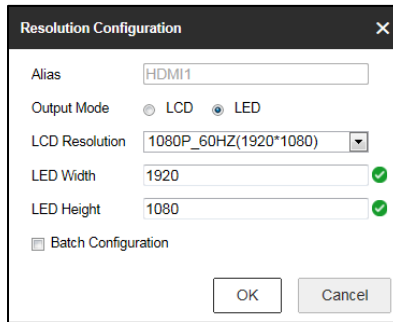

Figure 6-18 Set LED Resolution

NOTE

- The value of LED width and height cannot exceed the output resolution you select.
- The supported min. value of LED width × height of HDMI output is 288 × 288 and the max. value is 1920 × 1080.

Step 4 Check the checkbox of **Batch Configuration** to set the same configuration for other outputs with same signal source.

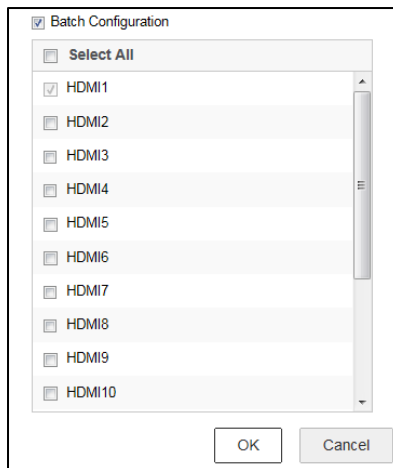

Figure 6-19 Batch Configuration

Step 5 Click **OK** to save the settings.

Step 6 Right click one of the HDMI signal sources and click **Output Mode Configuration** to pop up the interface below.

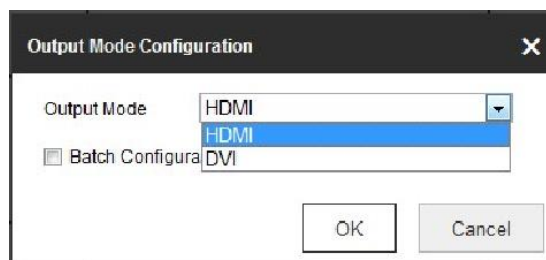

Figure 6-20 Output Mode Configuration

Step 7 Select the output mode to HDMI or DVI.

Step 8 Check the checkbox of **Batch Configuration** to set the same configuration for other HDMI outputs.

Step 9 Click **OK** to save the settings.

6.4 Decoding Video on Video Wall

Purpose

You can decode the video of the encoding devices on the video wall by dragging the channel directly or opening window via coordinate.

6.4.1 Interface Description

Click **Video Wall** to enter the video wall interface.

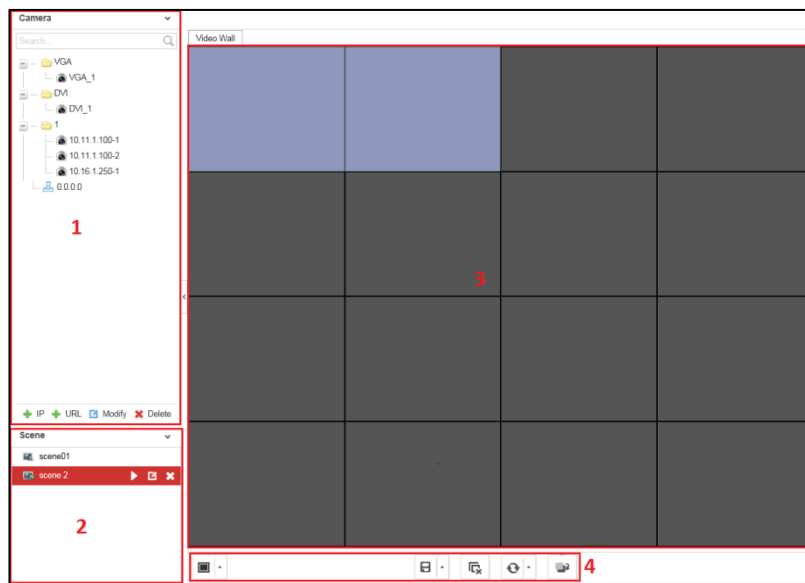







Figure 6-21 Video Wall Interface

Refer to the following figure for the video wall description.

Table 6-1 Description of Video Wall

No.	Description
1	Encoding Device List: The encoding devices added in the Web
2	Scene: The Web supports up to 8 scenes by default, capable of independent scene configuration and fast switching.
3	Video Wall: Video wall operation interface
4	<p>Shortcut Toolbar:</p> <p> Select decoding screen layout.</p> <p> Save the scene</p> <p> Delete all windows</p> <p> Refresh all windows</p> <p> If two decoding windows overlap with each other, click the icon to switch the upper window to the bottom.</p>

6.4.2 Dragging Channels to the Video Wall

Step 1 Drag the channel from the left side list to realize the decoding in the selected window.

You can also drag an area file to the video wall to decode the added encoding devices in the area file on the video wall.

NOTE

- You cannot drag an area file to the video wall across the LCD and LED outputs.
- If there are more than 3 encoding devices in an area, when you drag the area file to the video wall, the note pops up to remind you that no more window can be opened or the total area of layers in single-screen has reached the limit. Only the first 3 encoding devices in the area file can be decoded on the video wall.

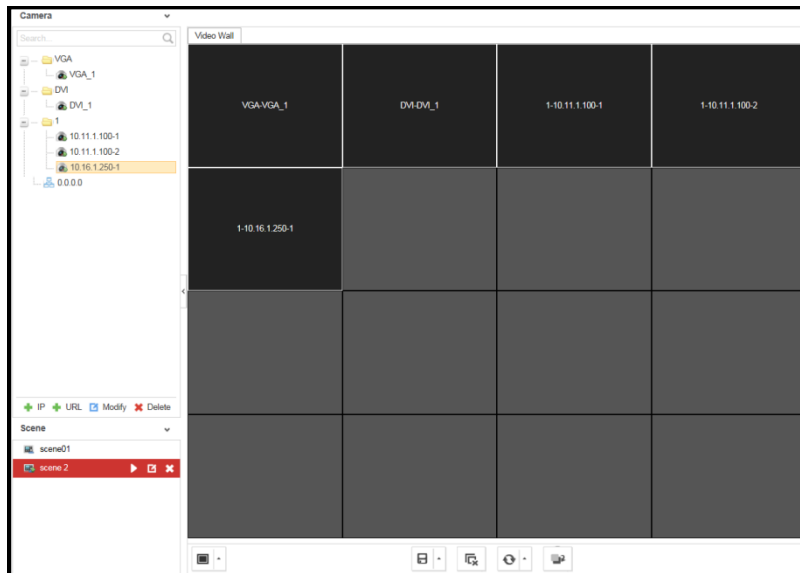

Figure 6-22 Decode the Video on the Wall

Step 2 Select one decoding window and click  to set the decoding screen layout.

1/2/4/6/8/9/12/16/25/36 window division modes are available.

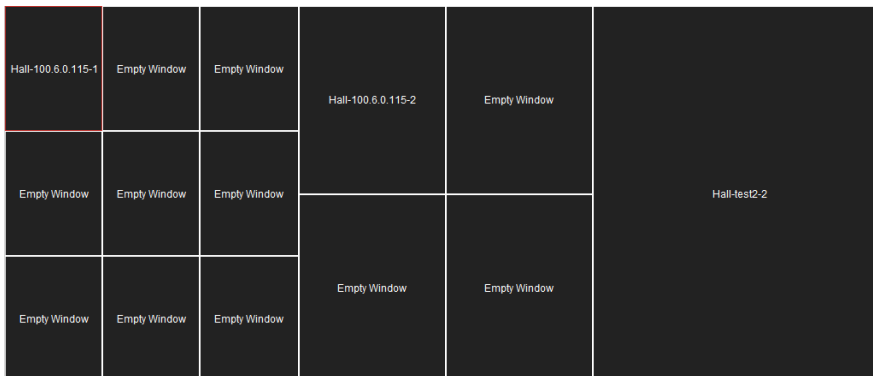

Figure 6-23 Window Division

6.4.3 Opening Window via Coordinate

Step 1 Select one encoding device and right-click it to pop up the interface below.

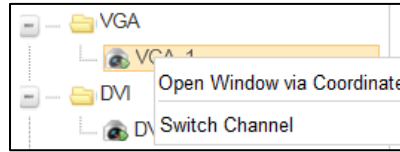

Figure 6-24 Right-Click Menu

Step 2 Click **Open Window via Coordinate**.

Step 3 Select the **Window Opening Mode**. LCD and LED are selectable.

- **Opening Window via Coordinate for LCD Output**

- 1) Select the **Window Opening Mode** as **LCD**.
- 2) Enter the **Left Margin**, **Right Margin**, **Width** and **Height** in the corresponding text fields.
- 3) Click **OK** to save the settings.

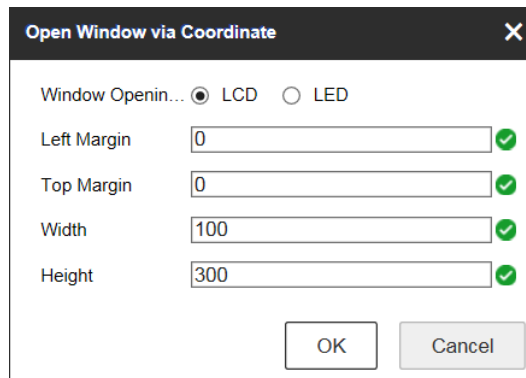

Figure 6-25 Open Window via Coordinate for LCD Output

- 4) The window will be opened in the LCD area.

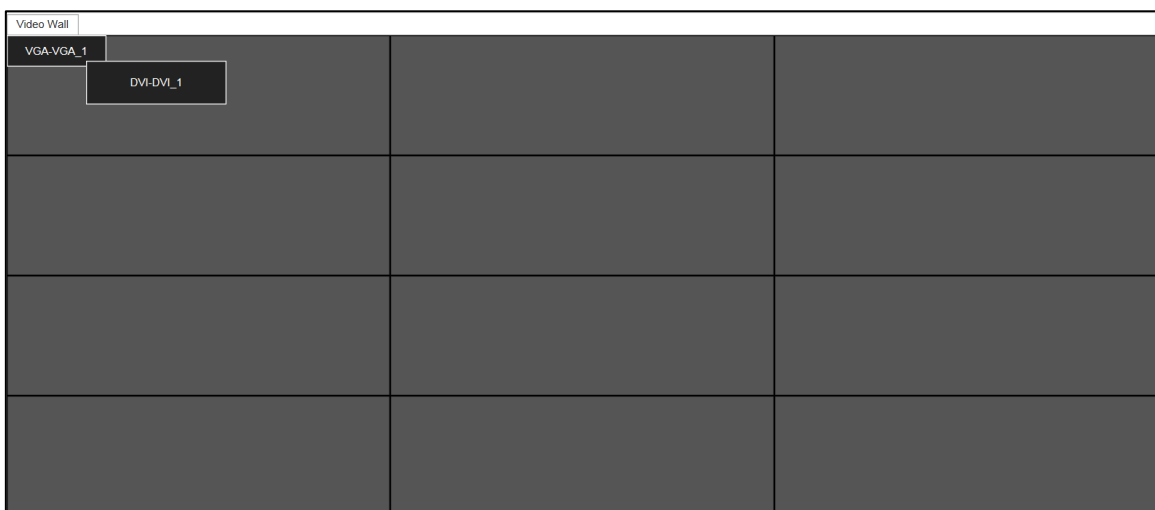

Figure 6-26 Window Opened in LCD Area

- **Opening Window via Coordinate for LED Output**

- 1) Select the **Window Opening Mode** as **LED**.
- 2) Select the **LED** area.

The area number depends on the HDMI decoding output configuration. For the adjacent HDMI outputs, if the resolution is configured to be LED, and the LED width or height is same, they can be seen as one area. You can refer to *Chapter 6.3.2 Configuring HDMI Output*.

- 3) Enter the **Left Margin**, **Right Margin**, **Width** and **Height** in the corresponding text fields.
- 4) Click **OK** to save the settings.

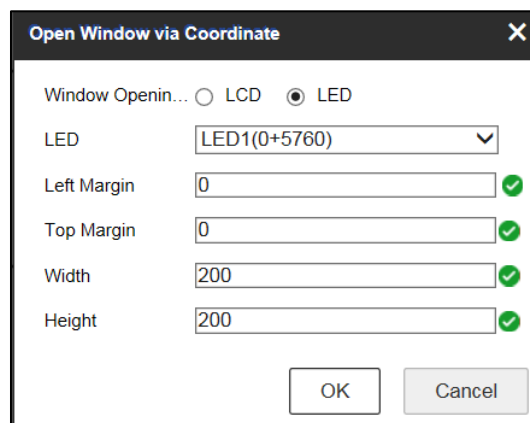

Figure 6-27 Open Window via Coordinate for LED Output

- 5) The window will be opened in the LED area.

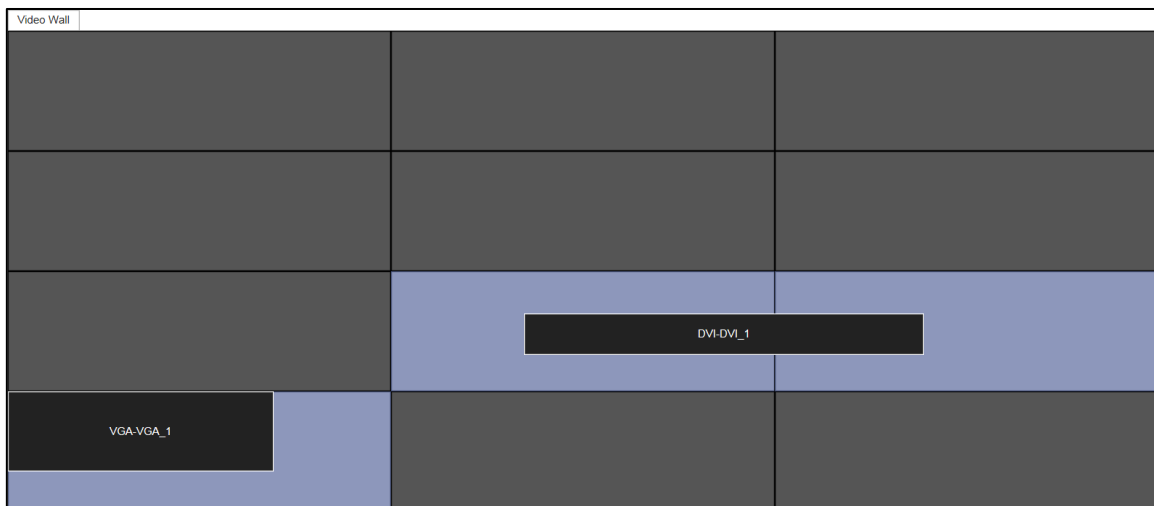

Figure 6-28 Window Opened in LED Area

6.4.4 Managing Decoding

Right-click the selected window and the Decoding Management interface pops up.

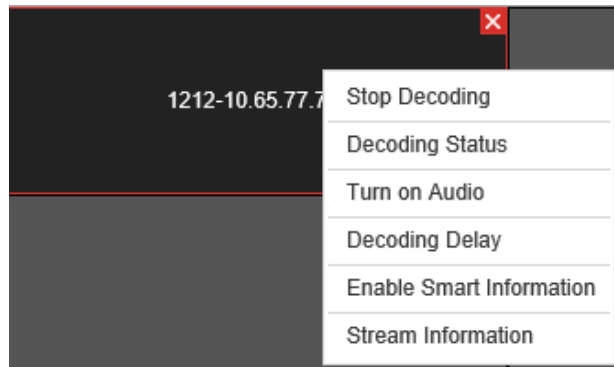

Figure 6-29 Decoding Management

● **Stop Decoding**

Click the button to stop decoding.

● **Decoding Status**

1. Click the button to enter the decoding status interface.
2. View the decoding status.

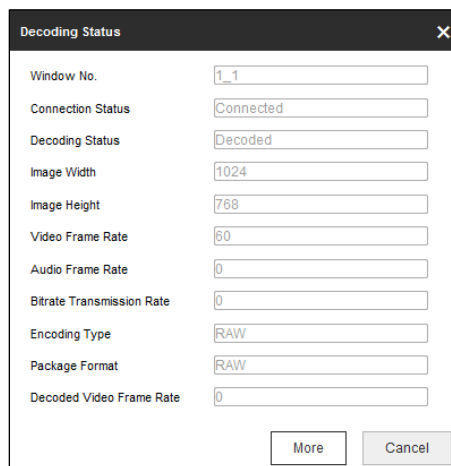

Figure 6-30 Decoding Status

3. Click **More** to check the decoding information of each channel.

Window..	Connection Status	Decoding Status	Image Width	Image Height	Video Frame Rate	Audio Frame Rate	Bitrate Transmission..	Encoding Type	Package Format	Decoded Video Fram..
1_1	Connected	Decoded	1280	720	59	0	0	RAW	RAW	10864
2_1	Connected	Decoded	1280	720	59	0	0	RAW	RAW	10446
3_1	Not connected	Not decoded	0	0	0	0	0	UNKNOWN	UNKNOWN	0
4_1	Not connected	Not decoded	0	0	0	0	0	UNKNOWN	UNKNOWN	0

Figure 6-31 Check More Decoding Status Information

● **Turn on Audio**

1. Click the button to enter the interface below.

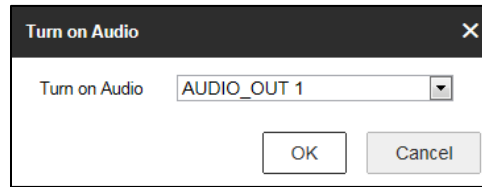

Figure 6-32 Turn on Audio

2. Select from the dropdown list to enable the audio in the corresponding window.
3. Click **OK** to save the settings.

● Decoding Delay

1. Click the button to enter the decoding delay interface.
2. Select the type of decoding delay. The default mode is the same with medium real time and fluency.

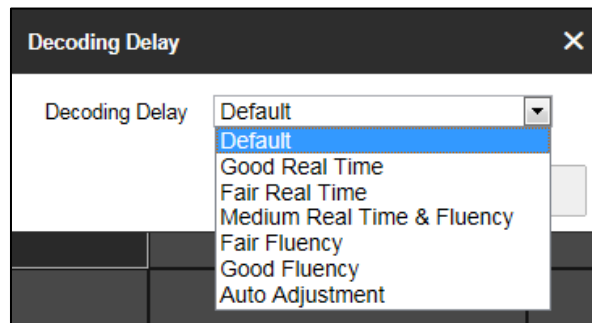

Figure 6-33 Decoding Delay

3. Click **OK** to save the settings.

● Enable Smart Information

1. Click the button to enable smart information.
2. (Optional) Click **Disable Smart Information** to disable the function.



NOTE

For the normal IP camera, the smart information refers to the VCA information. For the thermal network camera, the smart information refers to the VCA and the temperature, dynamic fire source detection and ship detection information.

● Stream Information

Click the button to view stream information such as host name and transport protocol.

6.4.5 Switching Encoding Channel

Purpose

You can switch the encoding channel to display on the selected decoding window.

Step 1 Select a decoding window and select an encoding channel from the left side list.

Step 2 Click **Switch Channel** from the right-click menu to switch the selected channel to the decoding window.

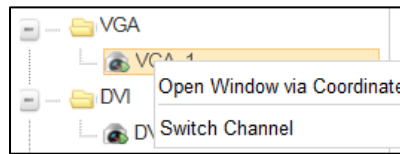

Figure 6-34 Right-Click Menu

6.4.6 Configuring Auto-Switch of Cameras

Purpose

You can enable auto-switch of the added cameras in one area.

Step 1 Select a camera area and click **Start Auto-Switch** from the right-click menu.

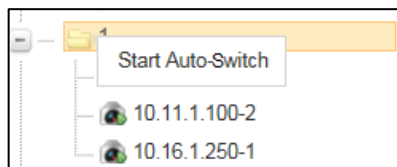

Figure 6-35 Right-Click Menu

Step 2 On the Start Auto-Switch interface, input the **Interval** for auto-switch.

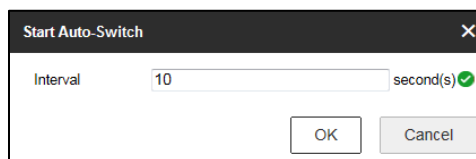

Figure 6-36 Start Auto-Switch

Step 3 Click **OK** to save the settings.

6.4.7 Roaming Window

Step 1 Drag one camera from the left side list to the video wall layout to enable decoding in the corresponding window automatically.

Step 2 Drag the decoding window randomly to realize the window roaming on the video wall.



Figure 6-37 Window Roaming

Step 3 Select one of the roaming windows, and click  to realize window division in the selected roaming window with 1/2/4/6/8/9/12/16/25/36 available.

Step 4 (Optional) Generally the selected window is at top by default. Click  to place the selected window at bottom.

 **NOTE**

- Roaming and fluent video cannot be realized in the window with the signal output via BNC interfaces.
- The roaming window cannot cross the output window of different resolution. For example, you cannot move the roaming window across the LCD and LED window.

6.4.8 Zooming in/out Roaming Windows

Purpose

You can double click the roaming window to zoom in or out.

- **For one roaming window:**

Step 1 Double click the roaming window to zoom in. Then the window will occupy the area with the same output.

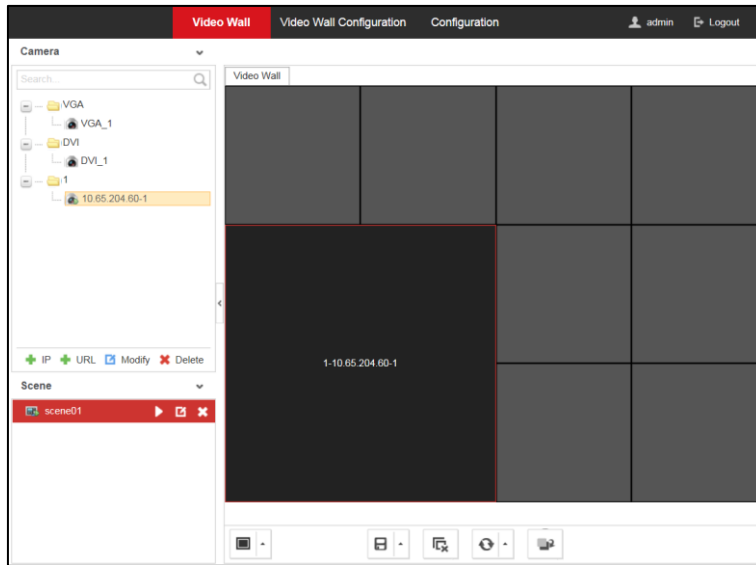

Figure 6-38 Zoom in

Step 2 Double click the window again to zoom out. Then the window will restore to the original size.

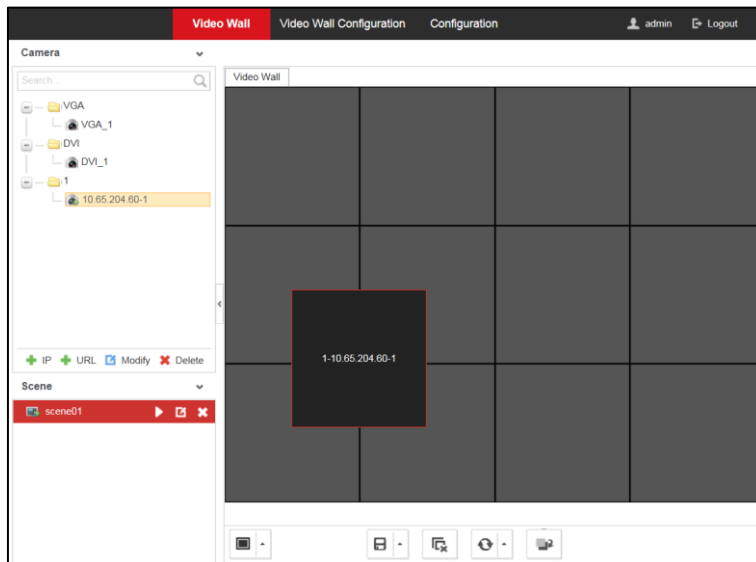

Figure 6-39 Zoom out

- **For divided roaming sub-window:**

Step 1 Double click the divided roaming sub-window to zoom in. Then the sub-window will occupy the whole window before being divided.

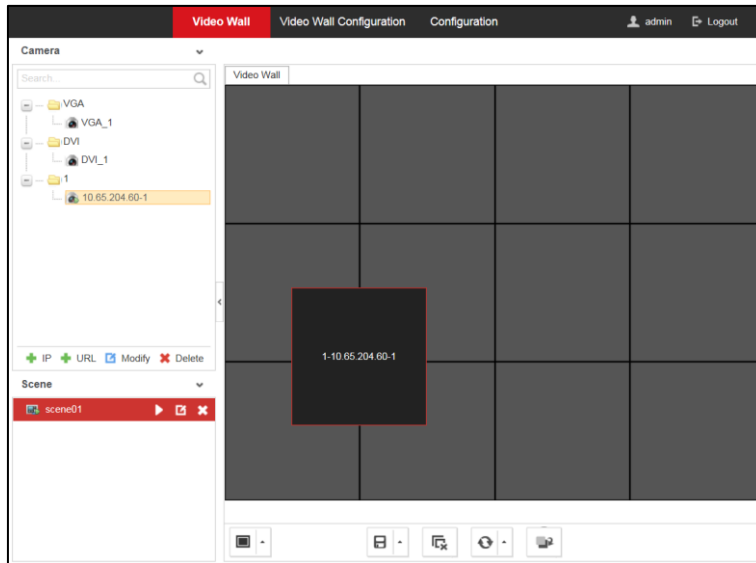

Figure 6-40 Zoom in

Step 2 Double click the divided roaming sub-window again to zoom out. Then the sub-window will restore to the original size.

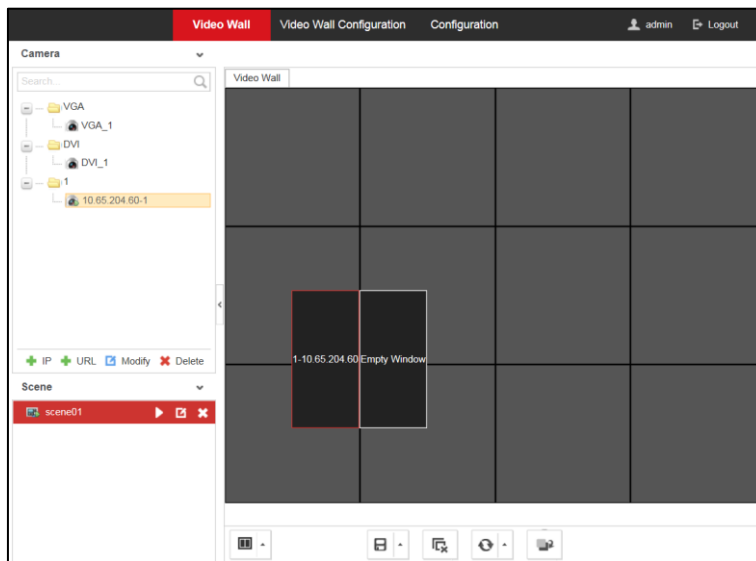

Figure 6-41 Zoom out

6.4.9 Configuring Scene

Purpose

Different video wall layouts can be saved as different scenes and up to 8 scenes can be added. You can easily view the required live videos on the video wall by calling the scene.

Step 1 In the Video Wall interface drag the channel from the left side list to realize the decoding in the selected window.

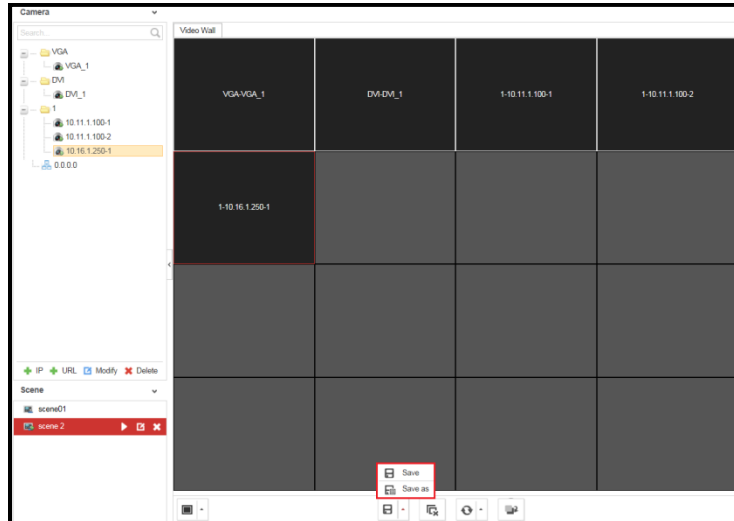

Figure 6-42 Save the Scene

Step 2 Click **Save** to save the scene directly or click **Save as** to pop up the following dialog box.

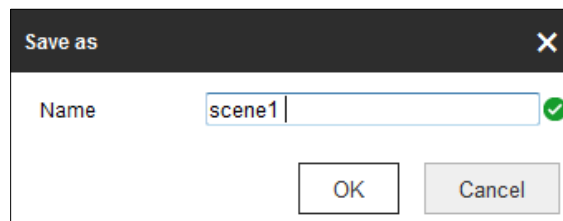

Figure 6-43 Save as Interface

Step 3 Input the **Name** and click **OK** to save the scene.

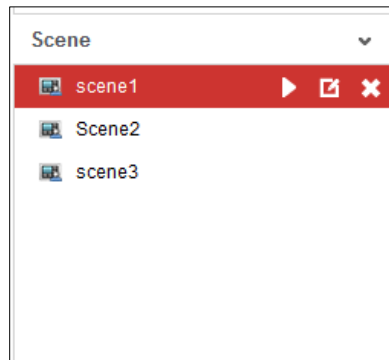





Figure 6-44 Scene List

Step 4 Select one of the scenes you have configured. Click  to call the scene.

Step 5 (Optional) You can also click  to rename the scene, or click  to delete the scene.

Chapter 7 User Management

Purpose

You can add, modify, delete, and set the permissions of the user accounts on the User Management interface.

Step 1 Click **Configuration > System > User Management** to enter the user management interface.

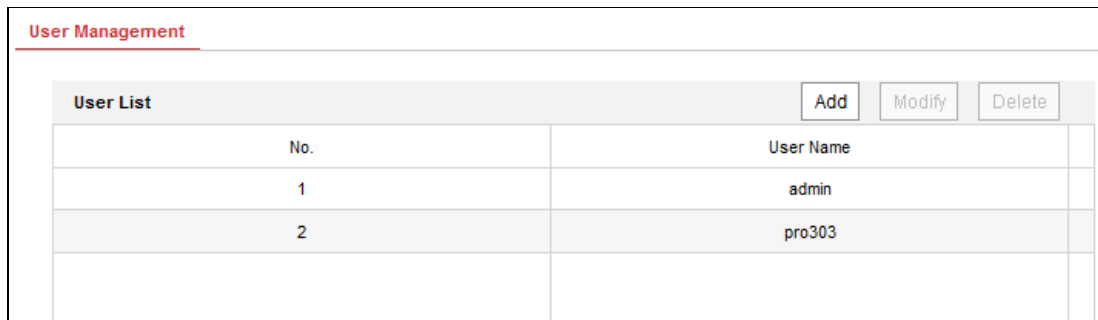

User List		Add	Modify	Delete
No.	User Name			
1	admin			
2	pro303			

Figure 7-1 Configure User Account

Step 2 You can add, modify or delete the user account, as well as configure operating permissions for each user account.

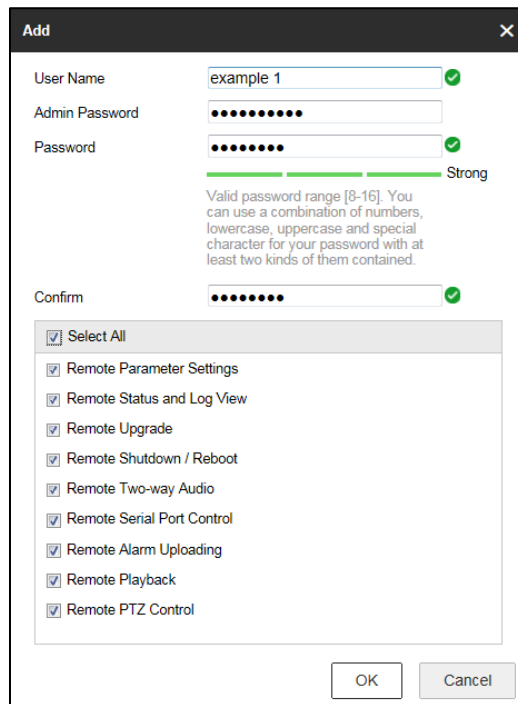

Add

User Name: example 1 ✓

Admin Password: ●●●●●●

Password: ●●●●●● ✓

Strong

Valid password range [8-16]. You can use a combination of numbers, lowercase, uppercase and special character for your password with at least two kinds of them contained.

Confirm: ●●●●●● ✓

Select All

- Remote Parameter Settings
- Remote Status and Log View
- Remote Upgrade
- Remote Shutdown / Reboot
- Remote Two-way Audio
- Remote Serial Port Control
- Remote Alarm Uploading
- Remote Playback
- Remote PTZ Control

OK Cancel

Figure 7-2 Add User Account and Set Permissions

 **NOTE**

- Up to 32 user accounts can be added including the *admin*.
 - For the admin user, only the password can be modified.
 - You must input the admin password if you want to modify the user account except the *admin*.
-

 **WARNING**

STRONG PASSWORD RECOMMENDED—We highly recommend you create a strong password of your own choosing (Using a minimum of 8 characters, including at least three of the following categories: upper case letters, lower case letters, numbers, and special characters.) in order to increase the security of your product. And we recommend you reset your password regularly, especially in the high security system, resetting the password monthly or weekly can better protect your product.

Chapter 8 System Configuration

8.1 Checking Device Information

Purpose

You can check the information of the device in the device information interface, such as the Physical Address, Device Type, Device Serial No., Firmware Version, Decoding Version, Web Version, Plugin Version, etc., and modify the Device Name.

Step 1 Click **Configuration > System > System Settings > Basic Information**.

Step 2 (Optional) Modify **Device Name**.

The default device name is *Embedded multiDecoder*. If you want to modify the device name to the model of the device, enter *Embedded multiDecoder + # + device model* in the text field.

Step 3 View other device information.



The description about the decoder configuration and operation by web browser below is based on the firmware, decoding, web and plugin version shown in the following figure.

Field	Value
Device Name	Embedded multiDecoder
Physical Address	8c:e7:48:9a:2d:02
Device Type	DS-6908UDI
Device Serial No.	DS-6908UDI0120171207CCRR785480060WCV
Firmware Version	V2.2.0 build 171212
Decoding Version	V2.2 build 171201
Web Version	V4.1.1 build 171208
Plugin Version	V3.0.5.40

Figure 8-1 Check Device Information

8.2 Configuring Time Settings

Purpose

You can set the time for the decoder in the **Time Settings** interface.

Step 1 Click **Configuration > System Settings > Time Settings** to enter the following interface:

Figure 8-2 Configure Time Settings

Step 2 Configure the time synchronization by NTP server or manually.

● Configuring Time Synchronization by NTP Server

A Network Time Protocol (NTP) Server can be configured on your device to ensure the accuracy of system date/time.

If the device is connected to a Dynamic Host Configuration Protocol (DHCP) network that has time server properties configured, the camera will synchronize automatically with the time server.

Enable the **NTP** function by selecting the radio button, and configure the following settings:

NTP Server: IP address of NTP server.

NTP Port: Port of NTP server.

Figure 8-3 Configure Time by NTP

NOTE

If the device is connected to a public network, you should use a NTP server that has a time synchronization function, such as the server at the National Time Center (IP Address: 210.72.145.44). If the device is set up in a more customized network, NTP software can be used to establish a NTP server used for time synchronization.

● Configuring Time Synchronization Manually

Enable the **Manual Time Sync.** function by selecting the radio button and then click icon  to set the system time from the pop-up calendar.

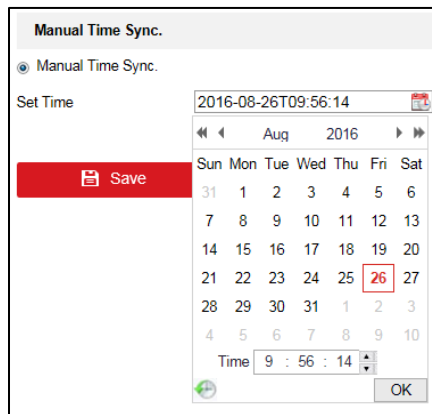

Figure 8-4 Configure Time Manually

Step 3 Select the time zone that is closest to the device's location from the drop-down list.

Step 4 Click **Save** to save the settings.

8.3 Configuring RS-232 Serial Port

Step 1 Click **Configuration > System Settings > RS-232** to enter the following interface:

Parameter	Value
RS-232 Port	1
Duplex	Full-duplex
Baud Rate	115200
Data Bit	8
Stop Bit	1
Parity	None
Flow Control	None
Working Mode	Console

Figure 8-5 Configure RS-232 Settings

Step 2 Configure the RS-232 parameters, including the baud rate, data bit, stop bit and parity type.

Step 3 Select the Operating Mode of RS-232 as Console or Transparent Channel.

Console: Use the RS-232 serial port for debugging the decoder.

Transparent Channel: Use the RS-232 serial port as the transparent channel.

Step 4 Click **Save** to save the settings.

8.4 Configure RS-485 Serial Port

Step 1 Click **Configuration** > **System Settings** > **RS-485** to enter the following interface.

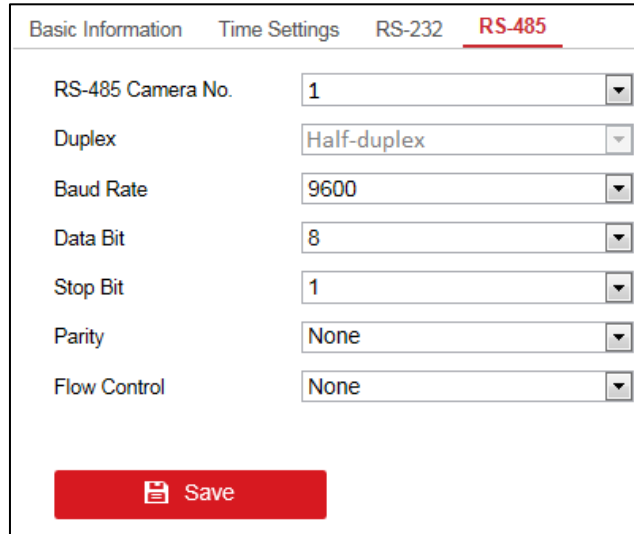

The screenshot displays the RS-485 configuration interface. At the top, there are four tabs: 'Basic Information', 'Time Settings', 'RS-232', and 'RS-485' (which is selected and underlined in red). Below the tabs, there are seven configuration items, each with a label and a dropdown menu:

Parameter	Value
RS-485 Camera No.	1
Duplex	Half-duplex
Baud Rate	9600
Data Bit	8
Stop Bit	1
Parity	None
Flow Control	None

At the bottom of the interface, there is a red button with a white floppy disk icon and the text 'Save'.

Figure 8-6 Configure RS-485 Settings

Step 2 Configure the RS-485 parameters, including the baud rate, data bit, stop bit and parity type.

Step 3 Click **Save** to save the settings.

Chapter 9 System Maintenance

Purpose

You can click **Configuration > System > Maintenance** to perform configuration files import/export, reboot, upgrade, and default operations.

9.1 Importing Configuration Files

Purpose

The configuration files of the device can be imported from the local device, which maintains convenient parameters configuration.

Step 1 Enter the parameters import interface.

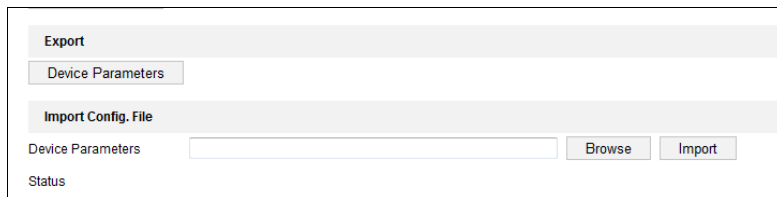

Figure 9-1 Import Configuration File

Step 2 Click **Browse** to select the file from the local directory and then click the **Import** button to import a configuration file. Click **Device Parameters** to export parameters.

9.2 Exporting Configuration Files

Purpose

The configuration files of the device can be exported to the local device, which maintains convenient parameters configuration.

Step 1 Enter the parameters export interface.

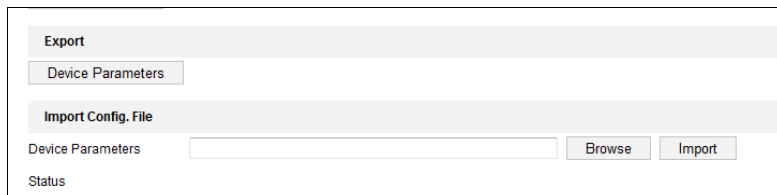

Figure 9-2 Export Configuration File

Step 2 Click **Device Parameters** to export parameters.

9.3 Upgrading the Device

Step 1 Enter the Upgrade interface.

Step 2 Click **Browse** to search the upgrading files.

Step 3 Click **Upgrade** to upgrade it.



Figure 9-3 Upgrade the Device

NOTE

- When logging in to the device for the first time, install the plug-in according to the prompt on the screen.
- The device will restart after completing the upgrade.

9.4 Restoring the Default Settings

Step 1 Enter the Default Settings interface.

Step 2 Click **Default** to restore the completed factory settings of the decoder.

Or click **Restore** to restore a part of the factory settings of the decoder.

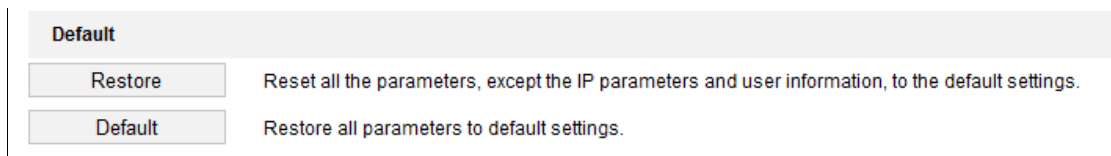

Figure 9-4 Restore Default Settings

9.5 Rebooting the Device

Step 1 Enter the Reboot Device interface.

Step 2 Click **Reboot** to reboot the device.



Figure 9-5 Reboot the Device

Chapter 10 Decoder Configuration and Operation by Client Software

Run the disk of iVMS-4200 Video Wall Client Software, and double click the icon to install it in your PC. In this chapter, the basic procedure of operating the decoder by the software is described.

10.1 Interface Description

The following figure shows the main interface after accessing to the software.

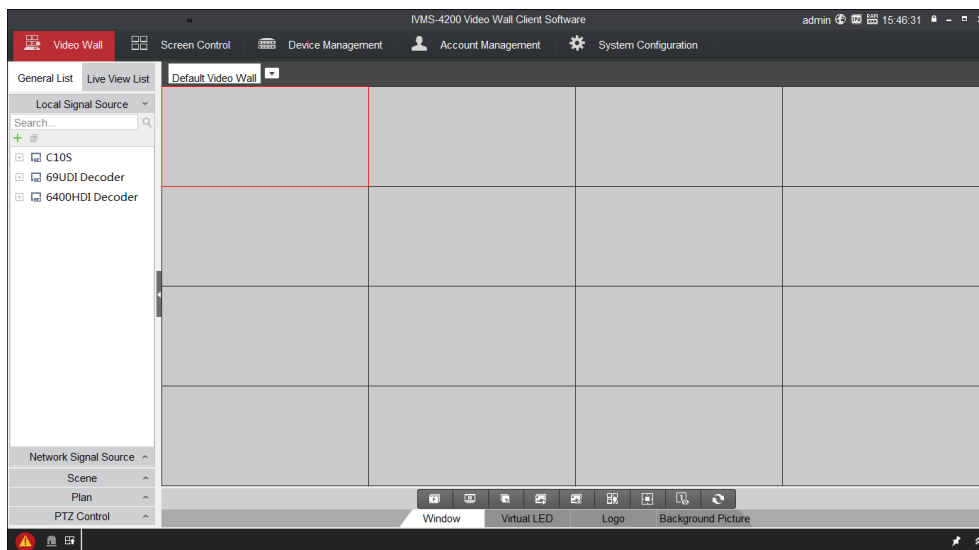







Figure 10-1 Main Interface

Refer to the following table for the description of the decoding toolbar on the bottom of the main interface.

Table 10-1 Decoding Toolbar

Icon	Name	Description
	Start/Stop Live View	Start/Stop live view of all the windows.
	Start/Stop All Decoding	Start/Stop decoding all signal sources and cameras.
	Close All Windows	Close all the windows displayed on the video wall.
	Start All VCA Decoding	Start VCA decoding for all live view signals. Once started, the VCA

		information can be viewed in live view.
	Stop All VCA Decoding	Stop VCA decoding for all live view signals.
	Open Window	Draw a window according to your need. The size and position of the window are adjustable.
	Open Window via Coordinate	Open a window by inputting X-coordinate, Y-coordinate, width and height.
	Show Window ID	Click it to show the window ID.
	Refresh	Refresh the video wall status.

 **NOTE**

The software is capable of many functions for controlling and managing many devices. In this manual, only the operation related to the decoder is introduced.

10.2 Adding an Encoding/Decoding Device

Step 1 Click **Device Management** tab to enter the Device Management interface.

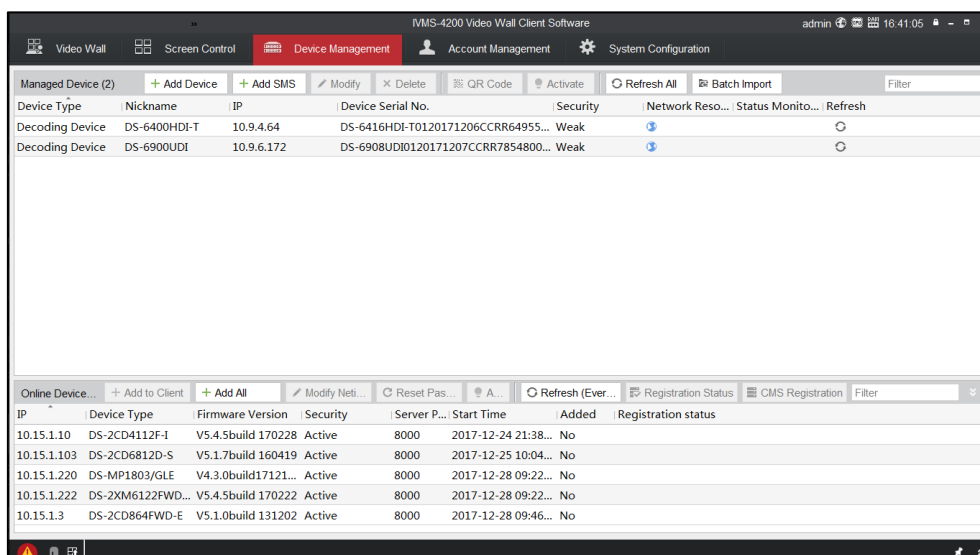

Figure 10-2 Device Management Interface

Step 2 Click **Add Device** and you can add device manually by means of IP address/domain, IP segment, and URL.

NOTE

An example of the URL format is as follows:

rtsp://10.9.1.233:554/h264/ch1/main/av_stream/?username=admin?password=hik12345?lnkmode=tc

In the above URL, **10.9.1.233** indicates the device IP, **admin** indicates the user name, **hik12345** indicates the password, and **tcp** indicates the stream transport protocol.

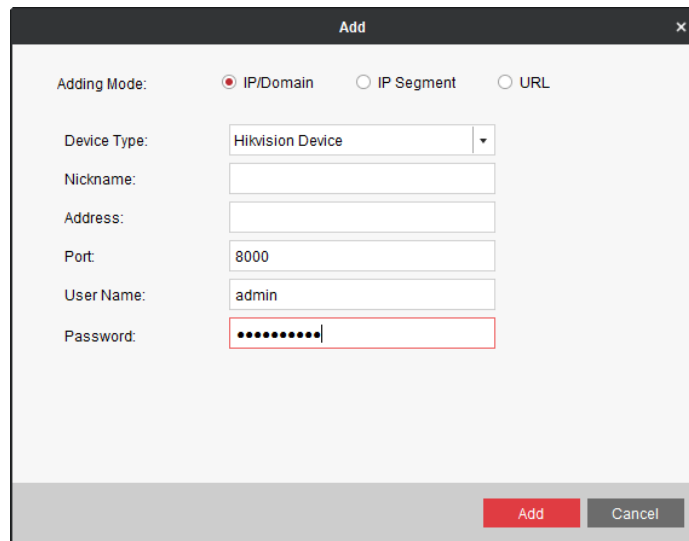

Figure 10-3 Add Device by IP/Domain

Step 3 You can add device by detecting the online devices. The active online decoding devices in the same local subnet with the software are displayed on the list. Select the decoder and click **Add to Client** to add the decoder.

IP	Device Type	Firmware Version	Security	Server Port	Start Time	Added
10.16.1.233	DS-6404HD-	V2.3.0 build 150604	Active	8000	2015-06-18 08:55:58	No
10.16.1.246	DS-2DF7286-A	V5.3.0 build 150321	Active	8000	2015-06-10 19:28:41	No
10.16.1.22	TS-5012-F	V4.1.0 build 150610	Active	8000	2015-06-19 13:40:27	No
10.16.1.221	IDS-2DF7284-A	V5.2.3 build 140828	Active	8000	2015-06-18 15:51:18	No
10.16.1.89	DS-KM8301	V1.1.0 build 150603	Active	8000	2011-06-04 14:14:54	No

Figure 10-4 Add Device by Detecting the Online Device

The successfully added encoding/decoding device can be viewed in the list.

Device Type	Nickname	IP	Device Serial No.	Security	Network Reso...	Refresh
Decoding Device	DS-6900UDI	10.11.1.166	DS-6916UDI0120160707BBRR257649817WCV	Weak		
Encoding Device	IP Dome	10.16.1.250	20141119CCWR490340679B	Strong		

Figure 10-5 List of Added Devices

10.3 Configuring Video Wall

10.3.1 Adding a Video Wall

Step 1 Click **Video Wall** tab to enter the Video Wall interface.

Step 2 You can use the default video wall layout or click  and select **Add Video Wall** to enter the Add Video Wall interface.



You can modify the default video wall, but not allowed to delete it.

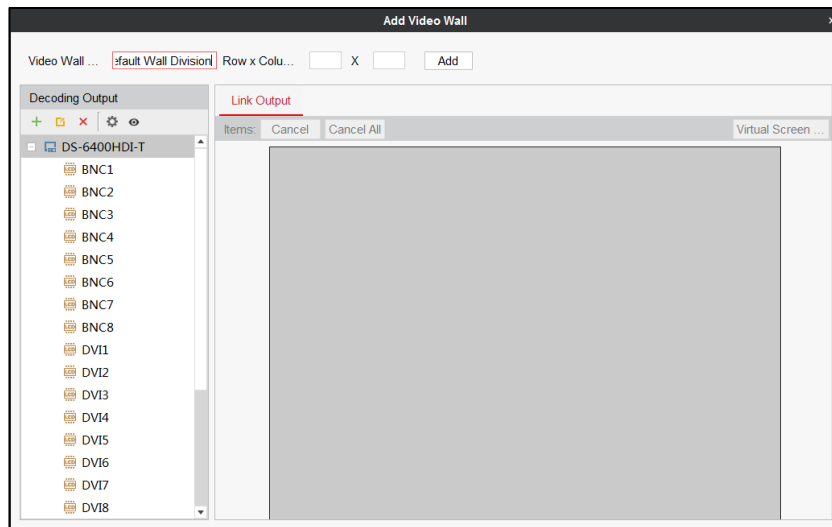

Figure 10-6 Add Video Wall

Step 3 Input the **Video Wall Name**, and the number of windows in row and column text fields.

Step 4 Click **Add** to add the video wall.



- Up to 5 video walls can be added to the client software.
- The range of the row number is between 1 and 16, and column number between 1 and 20.

Step 5 Drag the output channels from the left side list to link the decoding output to the video wall.

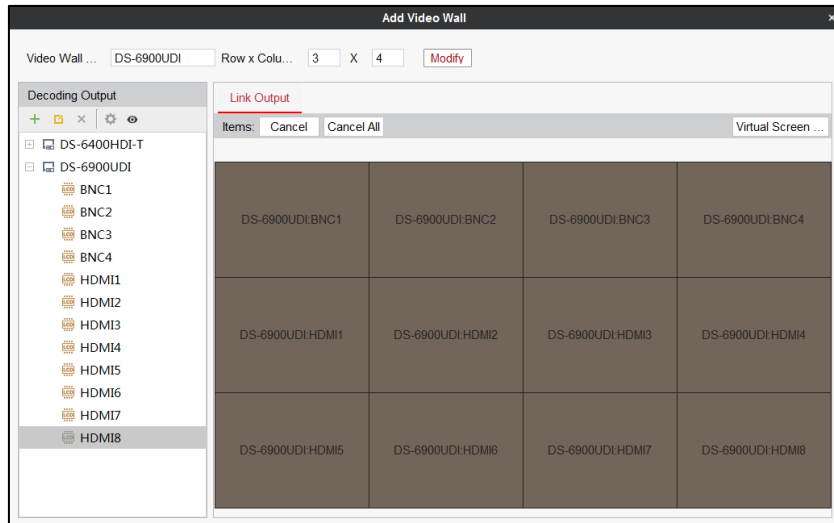

Figure 10-7 Link Decoding Output to Video Wall

Step 6 (Optional) You can select a linked display window and click **Cancel** to cancel the linkage, or click **Cancel All** to cancel all the linked windows.

10.3.2 Modifying a Video Wall

Step 1 Click **Modify Video Wall** to enter the Modify Video Wall interface.

Step 2 Edit the layout, name and decoding outputs of the current video wall.

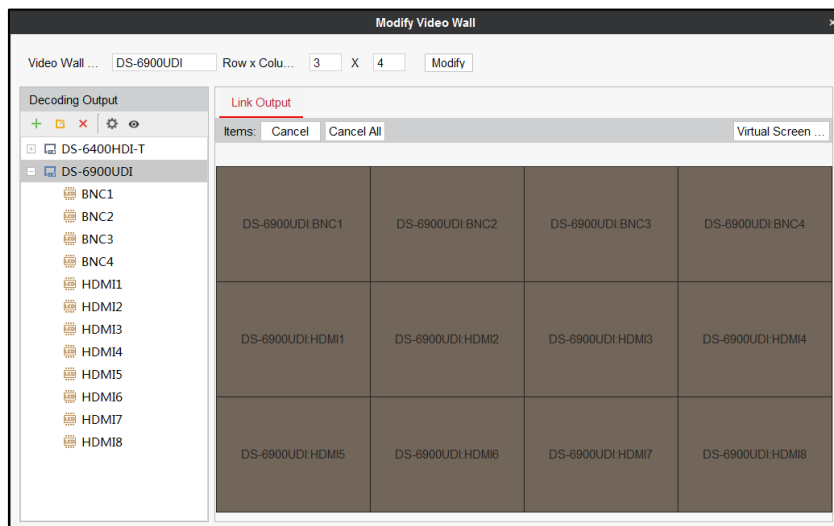

Figure 10-8 Modify Video Wall

10.3.3 Deleting a Video Wall

Step 1 Select **Delete Video Wall** and the information dialog box pops up.

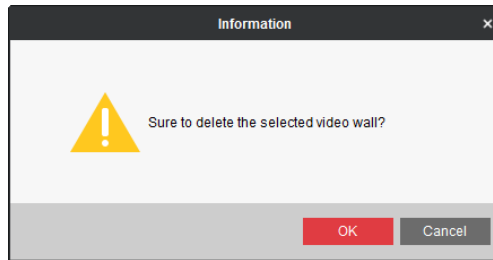



Figure 10-9 Delete Video Wall

Step 2 Click **OK** to delete the selected video wall.

10.3.4 Configuring Virtual Screen

Purpose:

Video wall layout is restricted by the physical screen and in practice, one physical screen usually displays more than one signal source. Virtual screen layout allows one physical screen to display multiple signal sources and get rid of the restriction of physical screen.

Step 1 On the Video Wall interface, click  and select **Modify Video Wall** to enter the Modify Video Wall interface.

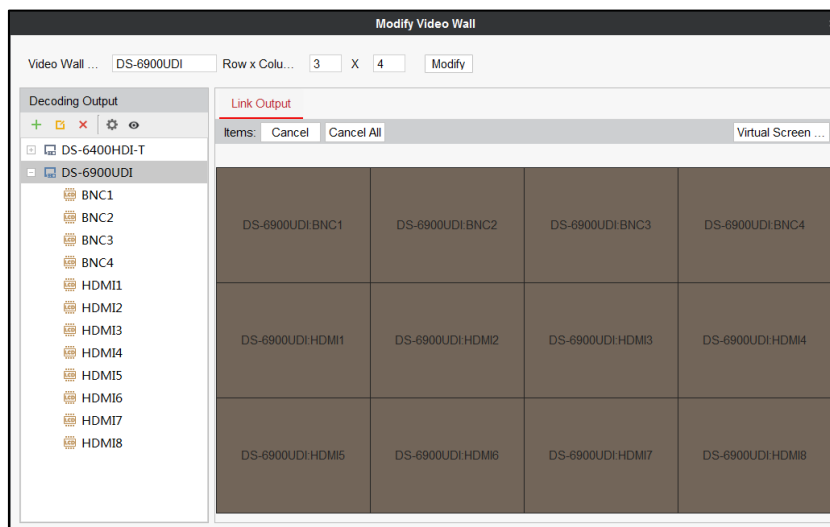

Figure 10-10 Modify Video Wall

Step 2 Select the output area for adding virtual screen.

Step 3 Click **Virtual Screen Config** to expand the **Virtual Screen Configuration** menu.

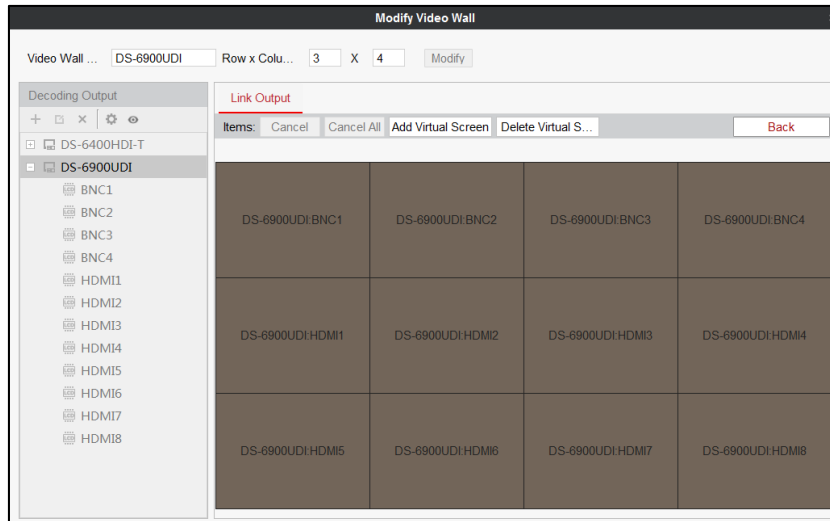

Figure 10-11 Configure Virtual Screen

Step 4 Select the window(s) you want to add virtual screen.



NOTE



You cannot add virtual screen across the LCD and LED areas.

Step 5 Click **Add Virtual Screen** to enter **Configure Virtual Screen** interface.

1. Select a virtual screen mode from  and input the row and column number.



NOTE

For the  mode, the row number ranges from 1 to 16 and column number ranges from 1 to 20. For modes such as , the row number ranges from 2 to 16 and the column number ranges from 2 to 20. For modes such as , the row number ranges from 2 to 16 and the column number ranges from 3 to 20.

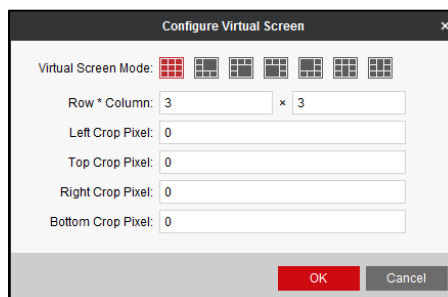

Figure 10-12 Configure Virtual Screen

2. Input the **Left Crop Pixel**, **Top Crop Pixel**, **Right Crop Pixel** and **Bottom Crop Pixel** in the corresponding text fields.

- Click **OK** to save the settings and the dotted line in grey constitutes the virtual screen division.

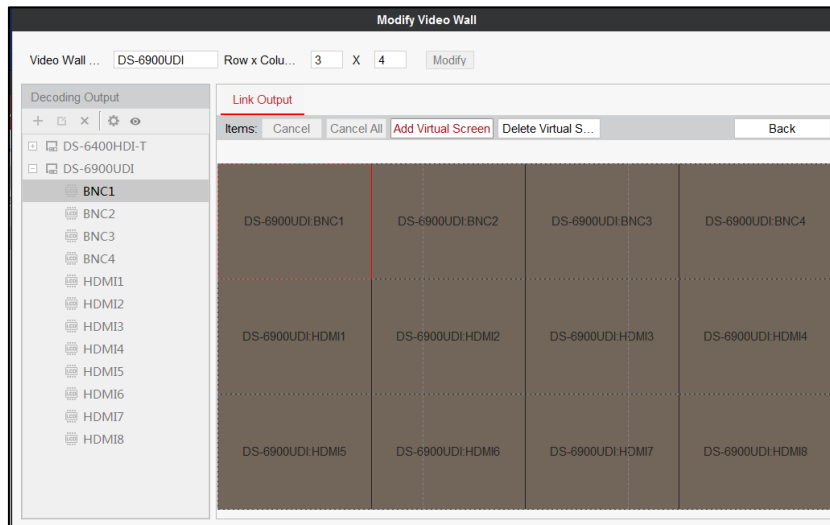

Figure 10-13 Added Virtual Screen

Step 6 (Optional) Select the configured virtual screen area and click **Delete Virtual Screen** to delete it.

Step 7 On the Video Wall interface, drag a signal source to the window, and you can view the live view in the virtual video wall layout.

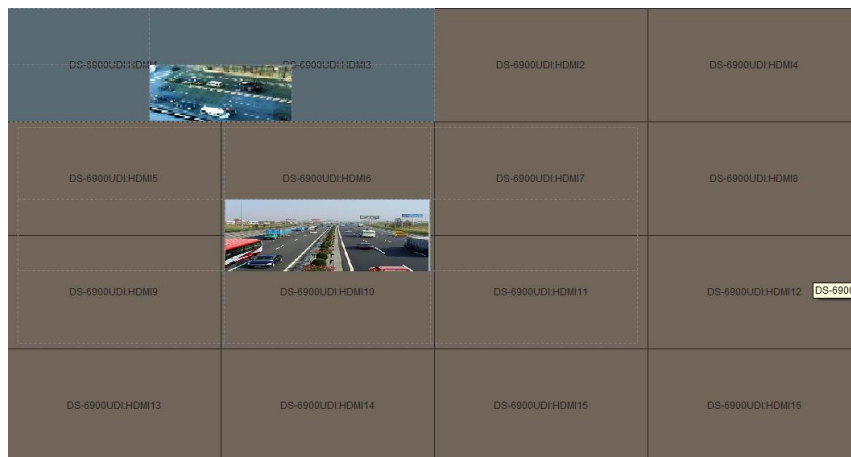



Figure 10-14 Live View in Virtual Screen

10.4 Configuring Decoding Parameters

Purpose

You can configure what the screen show when decoding ends and streaming fails, enable auto-switch of sub-stream, and set sub-window size on the Add/Modify Video Wall interface.

Step 1 On the Add/Modify Video Wall interface, select the added decoder and click  to enter the General Parameters Configuration of Video Wall interface.

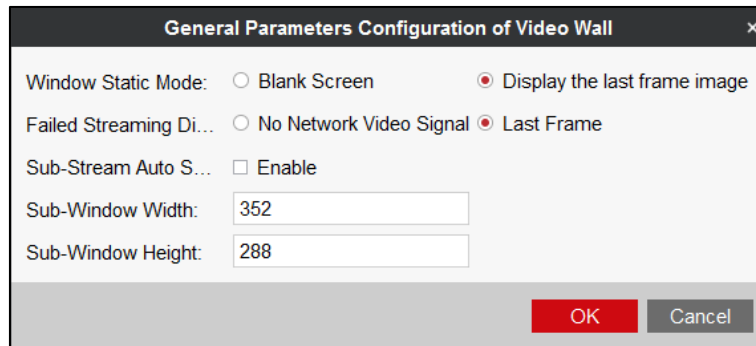

Figure 10-15 General Parameters Configuration of Video Wall

Step 2 Select **Blank Screen** or **Display the last frame image** for **Window Static Mode**. If you select **Blank Screen**, the screen will change blank when the decoding ends. If you select **Display the last frame image**, the screen will show the last frame when the decoding ends.

Step 3 Select **No Network Video Signal** or **Last Frame** for **Failed Streaming Display Mode**. If you select **No Network Video Signal**, the screen will show no signal when streaming fails. If you select **Last Frame**, the screen will show the last frame when streaming fails.

Step 4 (Optional) Check **Enable** of **Sub-Stream Auto Switch** to enable the function.

Step 5 Enter **Sub-Window Width** and **Sub-Window Height**. The width and height range from 1 to 640.

Step 6 Click **OK** to save the settings.

10.5 Configuring Decoding Output

Purpose

You can set the output type and resolution of BNC and HDMI decoding outputs on the Add/Modify Video Wall interface.

10.5.1 Configuring BNC Output

Step 1 On the Add/Modify Video Wall interface, select a BNC decoding output and click  to enter the Modify Output interface.

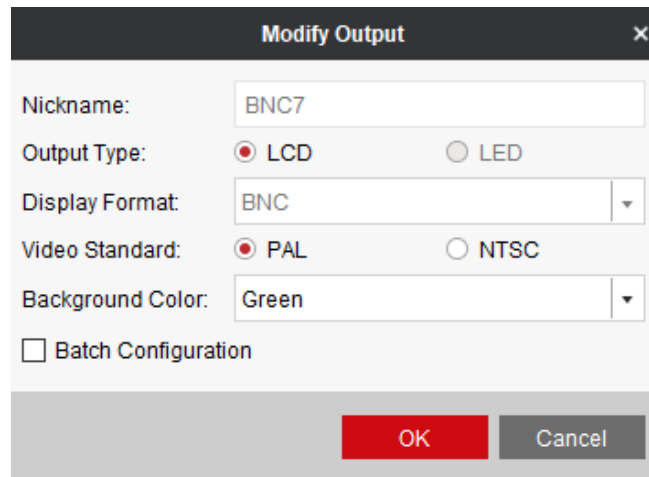

Figure 10-16 Modify BNC Output

Step 2 Select the **Output Type** and set the corresponding parameters. Only LCD output type can be configured.

Step 3 Select the **Video Standard**. **PAL** and **NTSC** are selectable.

Step 4 Set **Background Color** for the output. Eight colors are available and you can set a custom color.

 **NOTE**

If you set a background color for an output, the other two linked outputs are set as the same background color. BNC1, HDMI1, and HDMI2 are linked, BNC2, HDMI3, and HDMI4 are linked etc.

Step 5 Check **Batch Configuration** to set the same configuration for other outputs with same signal source.

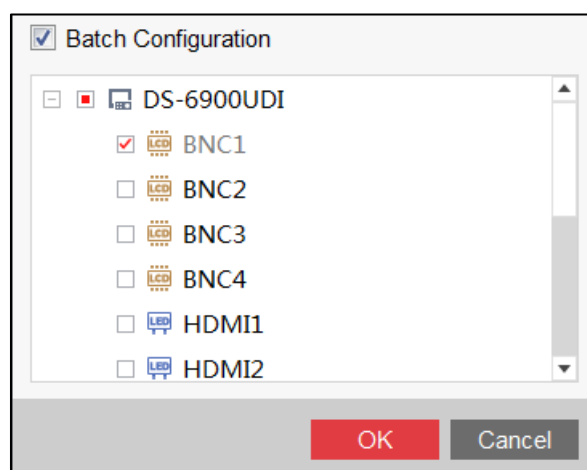

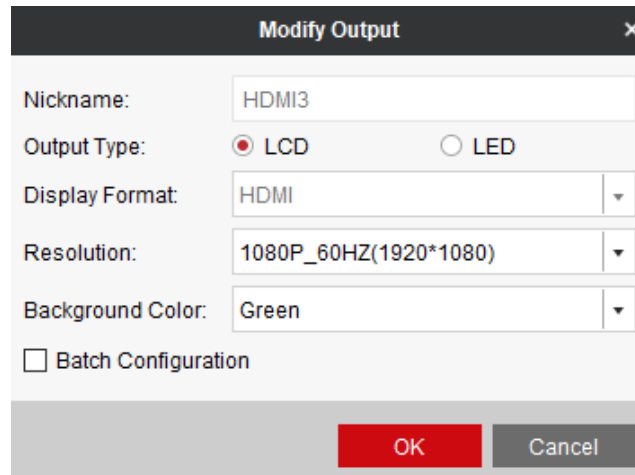

Figure 10-17 Batch Configuration

Step 6 Click **OK** to save the settings.

10.5.2 Configuring HDMI Output

Step 1 On the Add/Modify Video Wall interface, select a HDMI decoding output and click  to enter the Modify Output interface.



The screenshot shows a dialog box titled "Modify Output" with a close button (X) in the top right corner. The dialog contains the following fields and controls:

- Nickname: Text input field containing "HDMI3".
- Output Type: Radio buttons for "LCD" (selected) and "LED".
- Display Format: Dropdown menu showing "HDMI".
- Resolution: Dropdown menu showing "1080P_60HZ(1920*1080)".
- Background Color: Dropdown menu showing "Green".
- Batch Configuration: A checkbox that is currently unchecked.
- Buttons: "OK" (red) and "Cancel" (grey) buttons at the bottom right.

Figure 10-18 Modify HDMI Output

Step 2 Select the **Output Type** and set the corresponding parameters. You can select **LCD** and **LED**.

- **LCD**

1. Select the **Output Type** to **LCD**.
2. Select the **Resolution** from the drop-down list.
3. Set **Background Color** for the output. Eight colors are available and you can set a custom color.

- **LED**

1. Select the **Output Type** to **LED**.
2. Input the **Width × Height** in the corresponding text fields.
3. Set **Background Color** for the output. Eight colors are available and you can set a custom color.

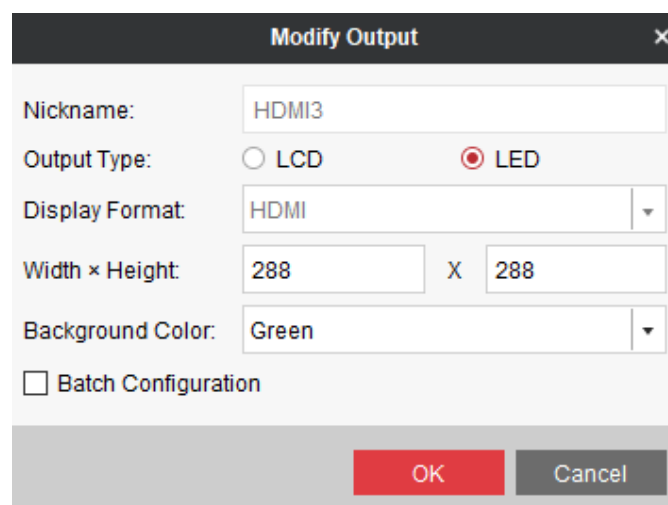

The screenshot shows the same "Modify Output" dialog box, but with the following changes:

- Output Type: Radio buttons for "LCD" and "LED" (selected).
- Width × Height: Two text input fields, the first containing "288" and the second containing "288", separated by an "X" symbol.
- Background Color: Dropdown menu showing "Green".
- Batch Configuration: A checkbox that is currently unchecked.
- Buttons: "OK" (red) and "Cancel" (grey) buttons at the bottom right.

Figure 10-19 Set LED Resolution

 **NOTE**

- The value of LED width and height cannot exceed the output resolution.
- The supported min. value of LED width × height of HDMI output is 288 × 288 and the max. value is 1920 × 1080.
- If you set a background color for an output, the other two linked outputs are set as the same background color. BNC1, HDMI1, and HDMI2 are linked, BNC2, HDMI3, and HDMI4 are linked etc.

Step 3 Check the checkbox of **Batch Configuration** to set the same configuration for other outputs with same signal source.

Step 4 Click **OK** to save the settings.

10.6 Operating Decoding

Purpose

After the settings of the encoding device, decoding device and video wall, the video stream from the encoding devices can be decoded and displayed on the video wall.

 **NOTE**

After enabling decoding and displaying, the video from the encoding devices can be displayed on the video wall. And the real-time live view is shown on the physical video wall.

10.6.1 Dragging Channels to the Video Wall

Step 1 Enter the Video Wall interface.

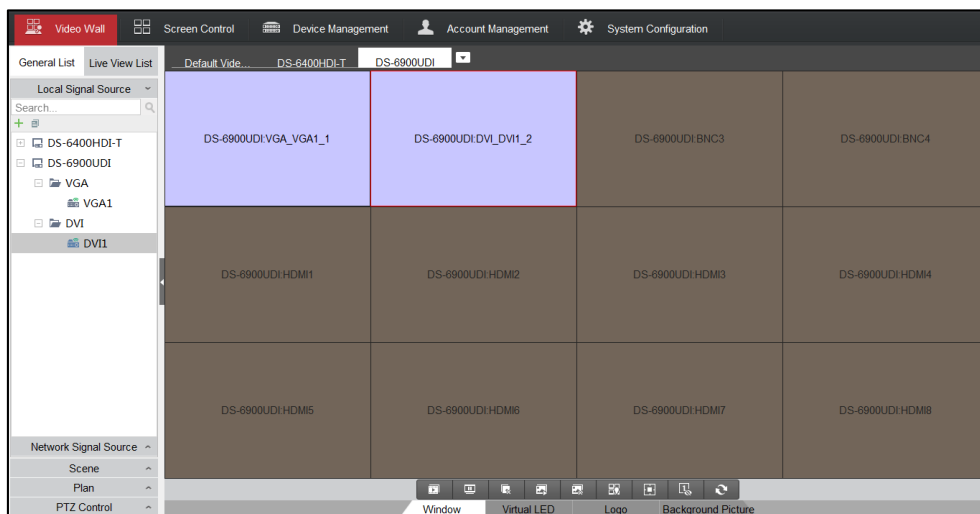



Figure 10-20 Video Wall Interface

Step 2 Drag the camera from the left side camera list to the display window of video wall. The video stream from the camera will be decoded and displayed on the video wall.

You can also select a decoding window and then double click a camera to decode and display the video. You can also hold the *Ctrl* or *Shift* key to select multiple cameras and then drag them to the video wall.



NOTE

You can click  on the lower part of the interface to stop decoding of all the windows.

10.6.2 Opening Window for Non-LED Screen

Purpose

On the non-LED screen, you are allowed to open the window via coordinate.

Step 1 Enter the **Video Wall** interface, select the non-LED screen and click the button  to open the window via coordinate.

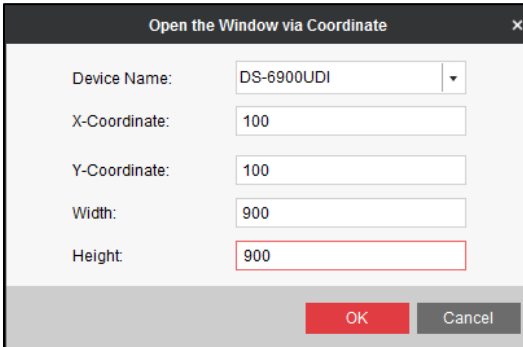

Figure 10-21 Open Window via Coordinate (1)

Step 2 Select the **Device Name** from the drop down list, and input the **X-Coordinate**, **Y-Coordinate**, **Width** and **Height**.

Step 3 Click **OK** to save the settings and the opened window will be displayed on the video wall.



NOTE

- You cannot open the window via coordinate across both the non-LED and LED screens.
- The X- coordinate and Y-coordinate are relative output channel coordinates.

10.6.3 Opening Window for LED Screen

Purpose

On the LED screen you are allowed to open the window via coordinate.

Step 1 Enter the **Video Wall** interface, select the LED screen and click the button  to open the window via coordinate.

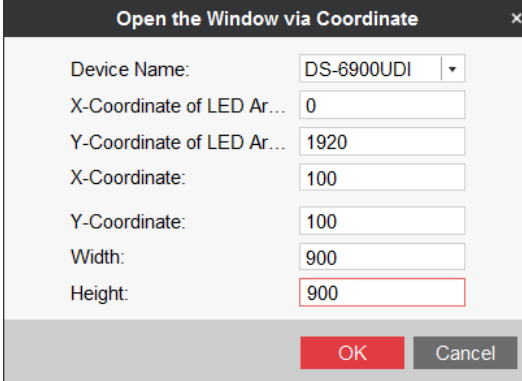

Field	Value
Device Name:	DS-6900UDI
X-Coordinate of LED Ar...	0
Y-Coordinate of LED Ar...	1920
X-Coordinate:	100
Y-Coordinate:	100
Width:	900
Height:	900

Figure 10-22 Open the Window via Coordinate (2)

Step 2 Select the **Device Name** from the drop down list, and input the **X-Coordinate**, **Y-Coordinate**, **Width** and **Height**.

Step 3 Click **OK** to save the settings and the opened window will be displayed on the video wall.

 **NOTE**

- You cannot open the window via coordinate across both the non-LED and LED screens.
- You cannot edit the X-Coordinate of LED Area and Y-Coordinate of LED Area.
- The X-coordinate and Y-coordinate are relative output channel coordinates.

10.6.4 Managing Decoding

Step 1 Right-click on a playing window to activate the decoding management menu as shown below.

 **NOTE**

The menu differs depending on the devices.

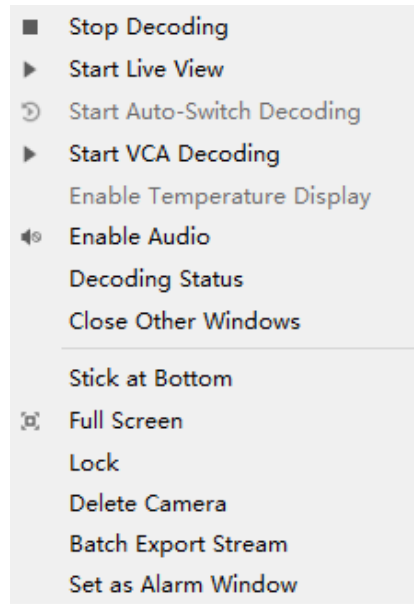

Figure 10-23 Right-click Menu

Step 2 Configure the following parameters.



- **Start/Stop Decoding:** Start/stop the decoding.
- **Start/Stop Live View:** Start/stop the live view of the decoded video. The smart information can be displayed in live view.
- **Start/Pause Auto-Switch Decoding:** Start/pause auto-switch decoding. This function is only supported by decoder.
- **Start/Stop VCA Decoding:** Start/stop VCA decoding.
- **Enable Audio:** Turn on/off the audio of the decoding video.
- **Decoding Status:** View the status of the decoding channel, like decoding status and stream type.
- **Close Other Windows:** Click it to close other decoding windows.
- **Stick at Bottom:** Generally the selected window is at top by default. Click **Stick at Bottom** to place the selected window at bottom.
- **Full Screen:** Click it to set the decoding window in full screen.
- **Lock/Unlock:** Click **Lock** to lock the window. The locked decoding window is unable to do any operation.
- **Batch Export Stream:** Record and export a segment of stream of one or multiple cameras to your local PC. A maximum of 16 cameras are supported at a time.
- **Set as Alarm Window:** Display the video triggered by event or alarm input on video wall.
- **Screen Control:** Enter screen control when the RSC server is added. Please refer to Chapter 10.8 for details.

10.6.5 Configuring Auto-Switch Decoding

Purpose

Auto-switch decoding refers to you can configure multiple video streams in a video output and the dwell time in switching video streams.

Step 1 Drag a camera group to the display window of the video wall.

Step 2 Click  to set the dwell time for the auto-switch decoding and click  to start auto-switch decoding. You can view the auto-switch decoding on the physical video wall. You can click  to stop auto-switch decoding.

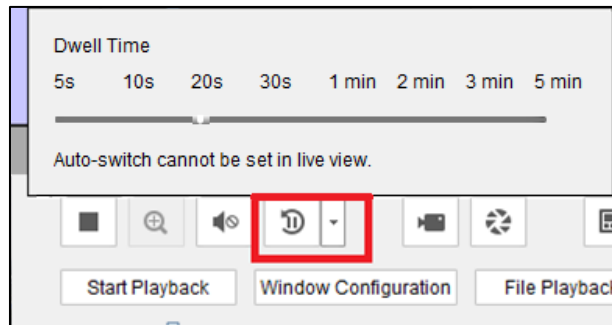

Figure 10-24 Auto-Switch Decoding

10.6.6 PTZ Control



This section is only applicable to the decoded cameras supporting PTZ control.

Step 1 Click **PTZ Control** to expand the PTZ control panel.

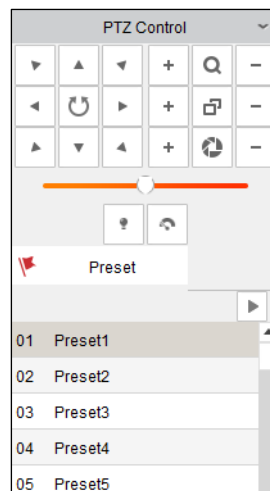

Figure 10-25 PTZ Control Panel

Step 2 Click the directional and functional buttons to set the preset.

10.6.7 Playback

Purpose

The video file is supported to be played back on the video wall.

 **NOTE**

Playback function is only supported by decoder.

Step 1 Drag the camera on the left-side list to the display window of video wall, or you can open a window if supported.

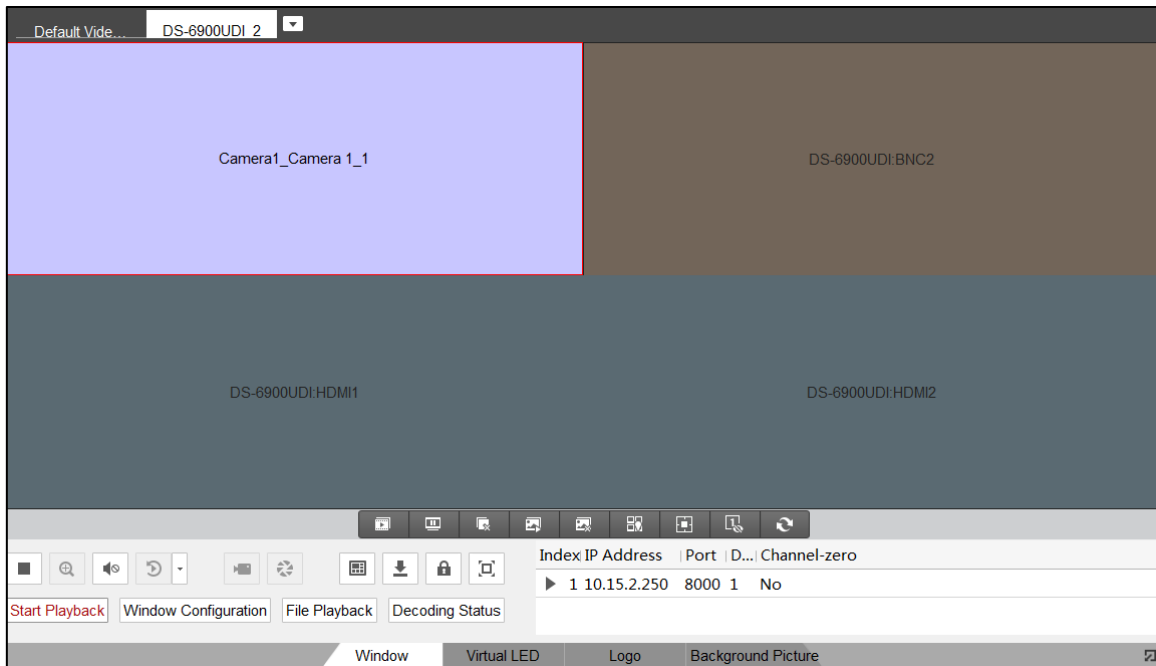

Figure 10-26 Video Wall

Step 2 Click **Window** at the bottom to unfold more configuration and operation toolbar.

Step 3 Click **Start Playback** to start searching the video files of the camera.

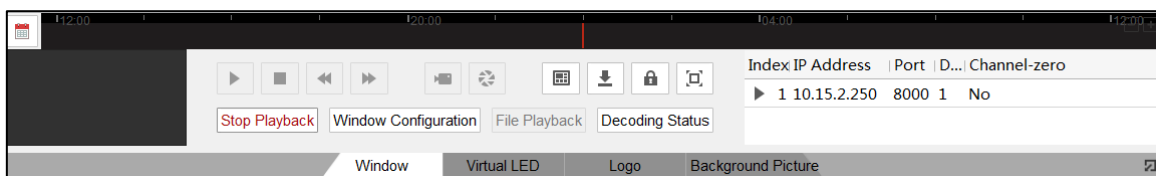



Figure 10-27 Playback Interface

Step 4 If the record file is of current day, the video file can be played back automatically. If not, you can click  to show the date and click **More Search Conditions** to specify more conditions, and click **Search** to find the video file.

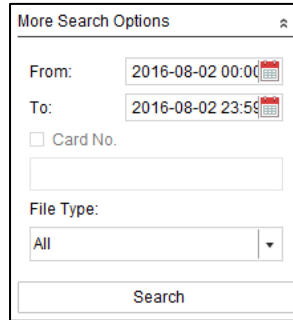

Figure 10-28 Search Record File

The following icons are available for controlling the playback.

Table 10-2 Playback Toolbar

Icon	Function
	Pause/Start the playback
	Delete View
	Slow Forward
	Fast Forward
	Start/Stop Clipping
	Capture

10.6.8 Configuring Scene

Step 1 Click **Scene** to expand the scene interface.

Step 2 You can click to add a new scene, click to edit the name for the scene, click to delete the scene and click to save the scene.

NOTE

Up to 8 scenes can be added.

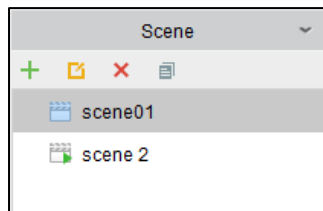

Figure 10-29 Scene List

10.6.9 Configuring Window

● Configuring Window Division Mode

Purpose

You can set the window division mode of the decoding window.

Step 1 Drag a camera from the left-side list to the display window of the video wall, or you can open a window.

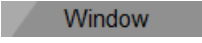
Step 2 Click  to expand the menu.

Step 3 Click  to select the window division mode. 1/2/4/6/8/9/12/16/25/36 modes are selectable.

● Zooming in/out Roaming Windows

You can double click the roaming window to zoom in or out. Refer to *Chapter 6.4.8 Zooming in/out Roaming Windows* for reference.

● Configuring Window Parameters

Purpose

You can set the window as the alarm window to display the video triggered by event or alarm input on the video wall. You can also set the decoding delay and image parameters.

Step 4 Drag the camera from the left-side list to the display window of the video wall, or you can open a window if supported.

Step 5 Click **Window Configuration** to pop up the configuration dialog box.

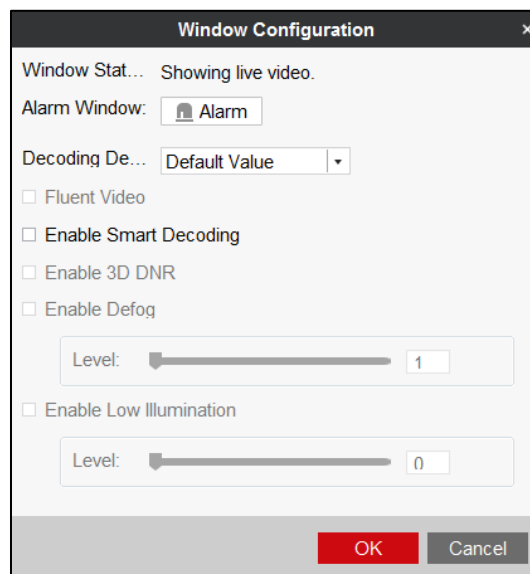

Figure 10-30 Window Configuration

Step 6 Configure the parameters as needed. The window status shows the current status of the selected window.

- **Alarm Window:** Display the video triggered by the event or alarm input on the selected window of the video wall.
- **Decoding Delay:** Set the delay status of the decoding according to the actual needs.



NOTE

Functions like Fluent Video, 3D DNR, Defog, and Low Illumination are not supported by DS-6900UDI.

10.7 Decoding Thermal Network Camera

Purpose

The thermal network camera can be connected to the decoder and you can realize live view and playback, and decode the video including the temperature or fire point information on the video wall.

10.7.1 Configuring the Thermal Network Camera Parameters

Purpose

You can configure the corresponding parameters of thermal network camera via the Web browser first before decoding it on the video wall.

Configuring Temperature Measurement

Step 1 Configure the VCA resource type.

1. Log in to the camera via the Web browser.
2. Click **Configuration > Advanced Configuration > System > VCA Resource Type** to enter the VCA Resource Type configuration interface.
3. Select **Temperature Measurement and Behavior Analysis** as the VCA Resource Type.
4. Click **Save** to save the settings.

Step 2 Configure temperature measurement.

1. Click **Configuration > Advanced Configuration > Temperature Measurement > Temperature Measurement Configuration** to enter the Temperature Measurement configuration interface.

Temperature Measurement Configuration		Temperature Measurement and Alarm
<input checked="" type="checkbox"/>	Enable Temperature Measurement	
<input checked="" type="checkbox"/>	Display Temperature Info. on Stream	
<input checked="" type="checkbox"/>	Add Original Data on Capture	
<input type="checkbox"/>	Add Original Data on Stream	
Data Refresh Interval	3	s
Unit	Degree Celsius(°C)	
Temperature Range	-20.0~150.0	

Save

Figure 10-31 Temperature Measurement Configuration

2. Check the checkboxes of the interface to set the temperature measurement configurations.
 - **Enable Temperature Measurement:** Check the checkbox to enable temperature measurement function.
 - **Display Temperature Info. on Stream:** Check the checkbox to display temperature information in live view.
 - **Add Original Data on Capture:** Check the checkbox to add original data on capture.
 - **Add Original Data on Stream:** Check the checkbox to add original data on stream.
3. Select the **Data Refresh Interval** from 1s to 5s.
4. Select the **Unit** to display temperature with Degree Celsius (°C)/Degree Fahrenheit (°F)/Degree Kelvin (K).
5. Configure the **Temperature Range**.
6. Click **Save** to save the settings.

Step 3 Configure the temperature measurement and alarm.

1. Click **Configuration > Advanced Configuration > Temperature Measurement > Temperature Measurement and Alarm** to enter the Temperature Measurement and Alarm configuration interface.

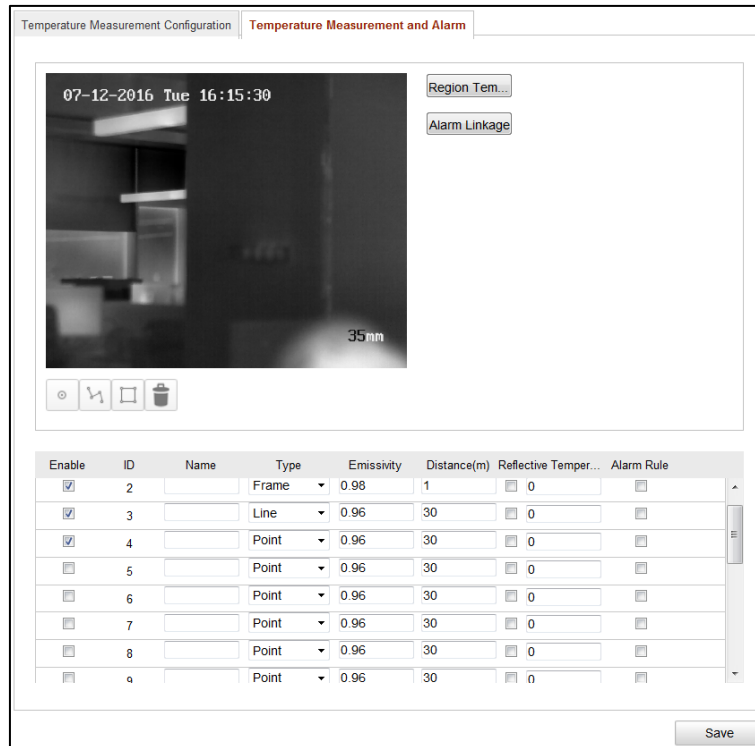

Figure 10-32 Temperature Measurement and Alarm

2. Set the alarm rule: Select a temperature measurement rule from the rule list and configure the parameters.

- **Name:** You can customize the rule name.
- **Type:** Select point, line, or frame as rule type.
- **Emissivity:** Set the emissivity of your target. The emissivity of each object is different.
- **Distance (m):** The straight-line distance between the target and the device.
- **Reflective Temperature:** If there is any target with high emissivity in the scene, check the checkbox and set the reflective temperature to correct the temperature. If no such target exists, uncheck the checkbox.

3. Click  in the list to show the alarm rule interface.

- **Alarm Rule:** The alarm rule varies according to different types. The rule is to compare the temperature information of two selected regions. For targets set by frame, the rules include: **Max. Temperature is Higher than**, **Max. Temperature is Lower than**, **Min. Temperature is Higher than**, **Min. Temperature is Lower than**, **Average Temperature is Higher than**, **Average Temperature is Lower than**, **Temperature Difference is Higher than**, and **Temperature Difference is Lower than**. For targets set by line, the rules include **Max. Temperature**, **Min. Temperature**, and **Average Temperature**. For targets set by point, the rules are distinguished by **Average Temperature**.
- **Pre-Alarm Temperature and Alarm Temperature:** Set the pre-alarm temperature and alarm temperature. The device sends pre-alarm when its rule temperature exceeds pre-alarm temperature and sends alarm when its rule temperature exceeds alarm temperature.



- **Tolerance Temperature:** Set the tolerance temperature and the device judges whether the triggered alarm stops until the device temperature/temperature difference is lower than rule temperature by tolerance temperature. For example, set tolerance temperature as 3°C, set alarm temperature as 55°C, and set pre-alarm temperature as 50°C. The device sends pre-alarm when its temperature reaches 50°C and it alarms when its temperature reaches 55°C and only when the device temperature is lower than 52°C will the alarm be cancelled.
4. Draw the Target Region. Select the rule and draw the corresponding frame/line/point.
Click  to draw the point. Click  to draw the line. Click  to draw the frame.



Figure 10-33 Draw Point



Figure 10-34 Draw Line



Figure 10-35 Draw Frame

- Set Temperature Difference Alarm. Click **Temperature Difference Alarm** to enter the temperature difference alarm interface, up to four temperature difference alarms can be set.

 **NOTE**

Temperature Difference Alarm is only applicable to the targets set by frame.

- Set Alarm Linkage. Click **Alarm Linkage** to enter the alarm linkage interface and set the linkage methods.
- Click **Save** to save the settings.

Step 4 Configure the local parameters to display the temperature information on the live view interface.

- Click **Configuration > Local Configuration** to enter the Local Configuration interface.

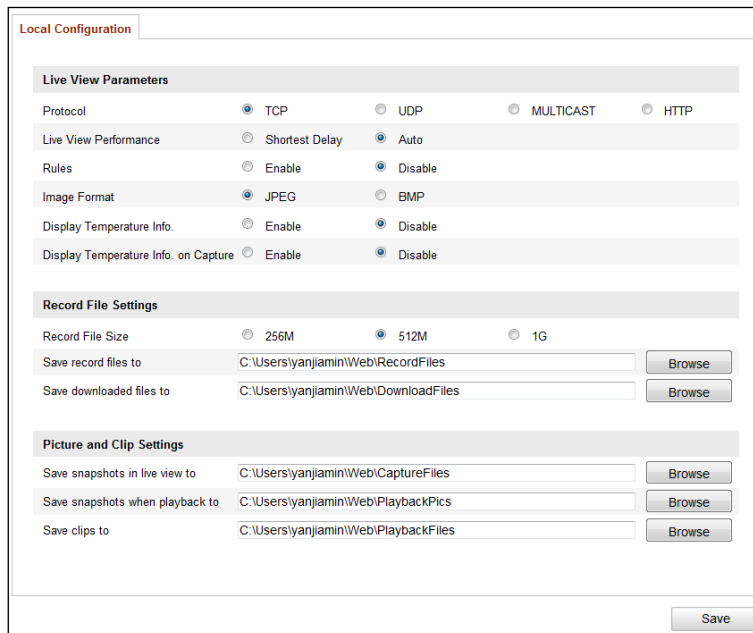

The screenshot shows the 'Local Configuration' interface with the following settings:

- Live View Parameters:**
 - Protocol: TCP, UDP, MULTICAST, HTTP
 - Live View Performance: Shortest Delay, Auto
 - Rules: Enable, Disable
 - Image Format: JPEG, BMP
 - Display Temperature Info.: Enable, Disable
 - Display Temperature Info. on Capture: Enable, Disable
- Record File Settings:**
 - Record File Size: 256M, 512M, 1G
 - Save record files to: C:\Users\yanjamin\Web\RecordFiles (Browse)
 - Save downloaded files to: C:\Users\yanjamin\Web\DownloadFiles (Browse)
- Picture and Clip Settings:**
 - Save snapshots in live view to: C:\Users\yanjamin\Web\CaptureFiles (Browse)
 - Save snapshots when playback to: C:\Users\yanjamin\Web\PlaybackPics (Browse)
 - Save clips to: C:\Users\yanjamin\Web\PlaybackFiles (Browse)

A 'Save' button is located at the bottom right of the interface.

Figure 10-36 Local Configuration

- In the Live View Parameters section, select the **Enable** radio button of **Display Temperature Info. on Stream** to display the temperature information on the live view interface.
- Click **Save** to save the settings and then you can view the position of the configured point, line and frame, the ID and temperature information on the live view interface.

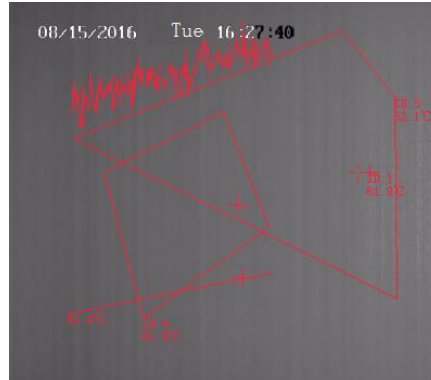

Figure 10-37 Live View

Configuring Dynamic Fire Source Detection

Step 1 Configure the VCA resource type.

1. Log in to the camera via the Web browser.
2. Click **Configuration > Advanced Configuration > System > VCA Resource Type** to enter the VCA Resource Type configuration interface.
3. Select **Dynamic Fire Source Detection** as the VCA Resource Type.
4. Click **Save** to save the settings and the device will reboot to take the settings into effect.



NOTE

For the VCA resource type, only one type can be configured. For example, if you select **Temperature Measurement and Behavior Analysis** as the VCA resource type, you cannot set **Dynamic Fire Source Detection**.

Step 2 Configure dynamic fire source detection parameters.

1. Click **Configuration > Advanced Configuration > Smart Event > Dynamic Fire Source Detection** to enter the Dynamic Fire Source Detection configuration interface.

Figure 10-38 Dynamic Fire Source Detection

2. Check the checkbox of **Enable Dynamic Fire Source Detection** to enable the function.
3. (Optional) Check the checkbox of **Display Fire Source Frame on Stream** to display a red frame around the fire source on stream when fire occurs.
4. You can slide the cursor to adjust the **Sensitivity** degree of dynamic fire source detection from 1 to 10. The bigger the number is, the more sensitive the detecting would be.
5. Check the checkbox to select the **Linkage Method** taken for the alarm input.
6. Click **Save** to save the settings.

Step 3 Configure the local parameters to display fire point distance, display highest temperature, locate highest temperature point or frame fire point on the live view interface.

1. Click **Configuration > Local Configuration** to enter the Local Configuration interface.

The screenshot shows the 'Local Configuration' interface with the following settings:

- Live View Parameters:**
 - Protocol: TCP, UDP, MULTICAST, HTTP
 - Live View Performance: Shortest Delay, Auto
 - Rules: Enable, Disable
 - Image Format: JPEG, BMP
 - Display Temperature Info.: Enable, Disable
 - Display Temperature Info. on Capture: Enable, Disable
- Record File Settings:**
 - Record File Size: 256M, 512M, 1G
 - Save record files to: C:\Users\yanjamin\Web\RecordFiles (Browse)
 - Save downloaded files to: C:\Users\yanjamin\Web\DownloadFiles (Browse)
- Picture and Clip Settings:**
 - Save snapshots in live view to: C:\Users\yanjamin\Web\CaptureFiles (Browse)
 - Save snapshots when playback to: C:\Users\yanjamin\Web\PlaybackPics (Browse)
 - Save clips to: C:\Users\yanjamin\Web\PlaybackFiles (Browse)

A 'Save' button is located at the bottom right of the interface.

Figure 10-39 Local Configuration

2. In the Live View Parameters section, check the checkbox after **Fire Point** to enable the functions required. **Display Fire Point Distance**, **Display Highest Temperature**, **Locate Highest Temperature Point** and **Frame Fire Point** are selectable.
3. Click **Save** to save the settings and then you can view the fire point distance, highest temperature, highest temperature point or fire point frame in the live view if fire point is detected.

Configuring Ship Detection

Step 1 Enter **Configuration > Advanced Configuration > System > VCA Resource Type** to select **Ship Detection** as the VCA Resource Type.

Step 2 Click **Configuration > Advanced Configuration > Smart Event > Ship Detection** to enter the Ship Detection interface.

Step 3 Check the checkbox of **Enable Ship Detection** to enable the function.

Step 4 Check the checkbox of **Display Detection Frame on Video** to display the frame and alarm line on stream.

Step 5 Input the device height in the textbox as the height of device above the water level.

Step 6 Draw the ship detection area and the alarm lines.

1. Click **Draw Area** button. Click the mouse on the live view image to draw a ship detection area and right-click to finish drawing. The alarm will be uploaded when ship is detected in this area.
2. Click **Draw Alarm Line** button. Click the mouse on the live view image to draw an alarm line and right-click to finish drawing. The device alarms and counts the ship number when ships are detected in the area and the ship information will be displayed on the right.



Make sure the alarm line is longer than the width of ship detection area.

3. Click **Recount** to start counting the ships detected in the area afterwards.

Step 7 Check the checkbox to select the linkage method taken for the alarm input.

Step 8 Click **Save** to save the settings.

Configuring VCA

Step 1 Configure the live view parameters to enable rules.

1. Click **Configuration > Local Configuration** to enter the Local Configuration interface.

The screenshot shows the 'Local Configuration' interface with the following settings:

- Live View Parameters:**
 - Protocol: TCP, UDP, MULTICAST, HTTP
 - Live View Performance: Shortest Delay, Auto
 - Rules: Enable, Disable
 - Image Format: JPEG, BMP
 - Display Temperature Info.: Enable, Disable
 - Display Temperature Info. on Capture: Enable, Disable
- Record File Settings:**
 - Record File Size: 256M, 512M, 1G
 - Save record files to: C:\Users\yanjamin\Web\RecordFiles (Browse)
 - Save downloaded files to: C:\Users\yanjamin\Web\DownloadFiles (Browse)
- Picture and Clip Settings:**
 - Save snapshots in live view to: C:\Users\yanjamin\Web\CaptureFiles (Browse)
 - Save snapshots when playback to: C:\Users\yanjamin\Web\PlaybackPics (Browse)
 - Save clips to: C:\Users\yanjamin\Web\PlaybackFiles (Browse)

A 'Save' button is located at the bottom right of the interface.

Figure 10-40 Local Configuration

2. On the **Live View Parameters** section, select the **Enable** radio button after **Rules** to display the colored marks when the motion detection, face detection, or intrusion detection is triggered. E.g., enabled as the rules are, and the face detection is enabled as well, when a face is detected, it will be marked with a green rectangle on the live view.

Step 2 Configure the VCA information.

1. Click **Configuration > VCA Configuration > VCA Info.** to enter the VCA Information interface.

Figure 10-41 VCA Information

2. On the **Display Information** section, check the checkboxes to enable corresponding displays.
 - **Display Target info. on Alarm Picture:** There will be a frame on the target on the uploaded alarm picture if the checkbox is checked.
 - **Display Rule info. on Alarm Picture:** The captured target and the configured area will be framed on the alarm picture.
 - **Display VCA info. on Stream:** The green frames will be displayed on the target if in a live view or playback.

Step 3 Configure the rules for VCA. Refer to the User Manual of Thermal Network Camera for the specific operations.

10.7.2 Decoding Thermal Network Camera on the Video Wall

Step 1 Add the thermal network camera to the video wall client software.

Step 2 On the Video Wall interface, drag the added thermal network camera to the video wall.

Step 3 Click  to start live view and you can view the corresponding information on the live view interface.

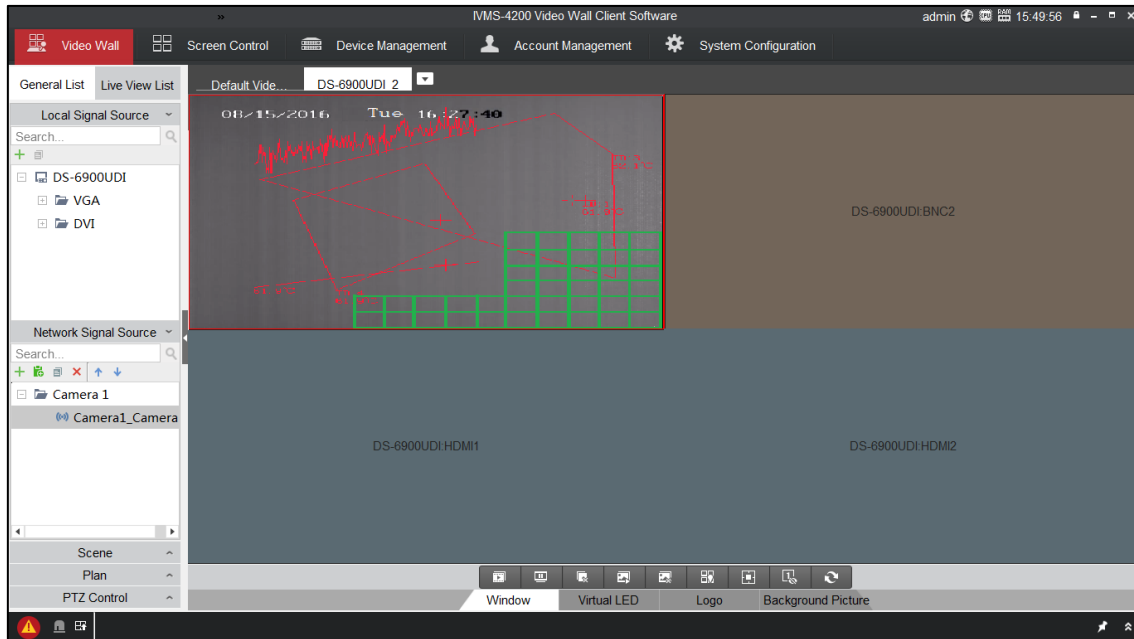



Figure 10-42 Decode Thermal Camera on the Video Wall

NOTE

- If VCA is enabled for the thermal network camera, the decoder can analyze the VCA behavior, mark the moving target and track it. You can view the VCA information marked in the green frames in the live view. If the rule configured for the thermal network camera is broken, the alarm will be triggered.
- If temperature measurement is enabled, you can view the position of the configured point, line and frame, the ID, and temperature information in the live view.
- If fire point detection is enabled and there is a fire point detected, you can view the configured fire point distance, highest temperature, highest temperature point and fire point frame in the live view.
- If ship detection is enabled and there is a ship detected, you can view the configured frames and alarm line in the live view.

Step 4 (Optional) You can click **Window** tab on the bottom of the interface and click **Start Playback** to start playing back the camera. Refer to *Chapter 7.5.7 Playback* for reference. The temperature measurement, fire source detection, ship detection and VCA information can be played back.

Step 5 (Optional) You can click  or click **Stop VCA Decoding** from the right-click menu to stop VCA decoding of the thermal network camera.

10.8 Controlling Remote Screen

Purpose

Installed with the RSC Server, it allows you to show your PC screen on the video wall. Follow the following procedure to configure the RSC server and get your screen shown on the video wall.

10.8.1 Configuring the RSC Server

Step 1 Install the RSE Server, which enables the PC screen to be displayed on the video wall, and

double-click  to run it.

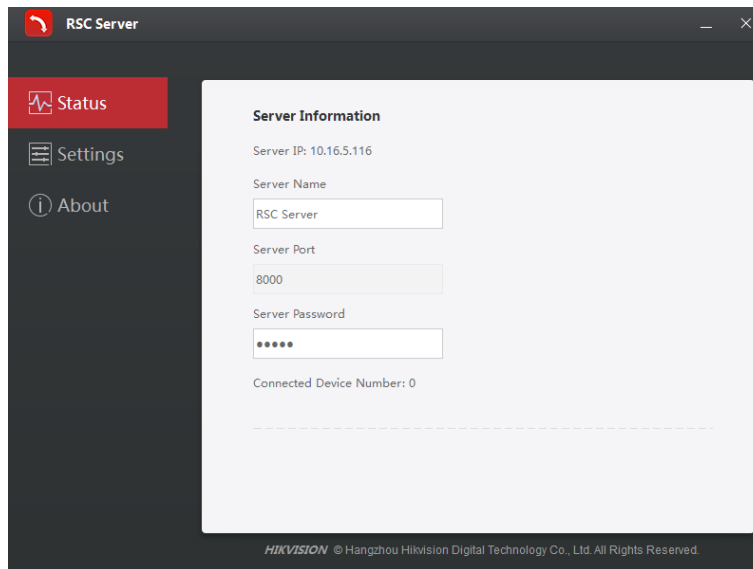

Figure 10-43 Run the RSC Server

Step 2 You can click **Status** to check the server information, including the IP address, name, port, password of the server, and the connected device number.

Step 3 Click **Settings** to check the directory of saving the program files, enable or disable the feature of Auto-Run when OS starts, and select the language (Chinese/English).

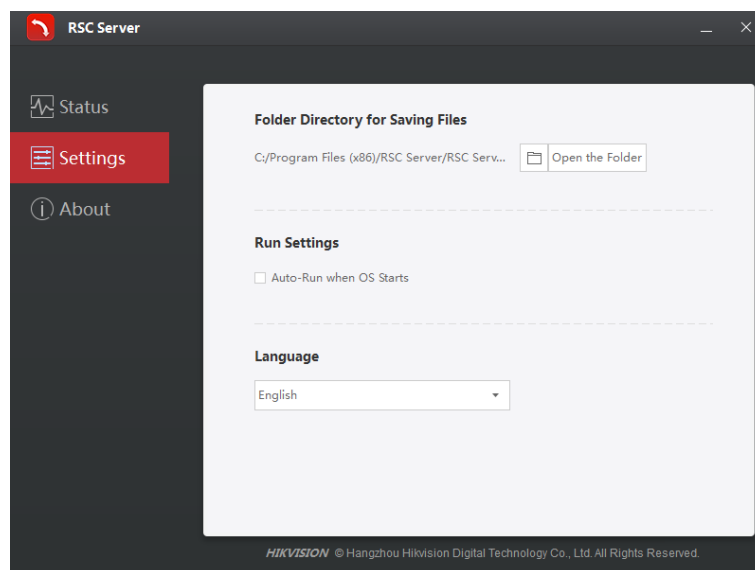

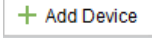

Figure 10-44 Local Configuration of RSC Server

10.8.2 Controlling Remote Screen via RSC Server

Step 1 Enter the Video Wall interface and click  in the Camera list area, or click  on Device Management interface to add the RSC server.

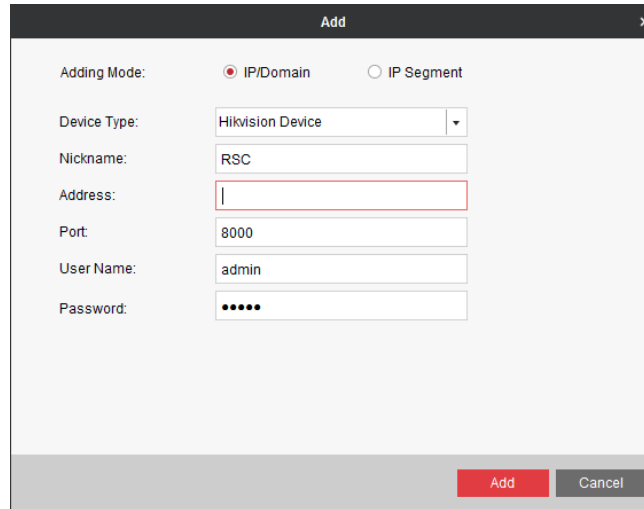

Figure 10-45 Add RSC Server

Step 2 Enter the parameters to add the RSC server. Please refer to *Chapter 7.1 Adding an Encoding /Decoding Device* to add the RSC server.

NOTE

The default user name is *admin* and the server password is 12345 and we highly recommend you to change the default password to avoid the security problem.

Step 3 The successfully added RSC server is listed in the camera list.

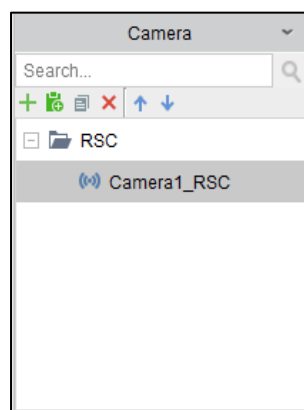

Figure 10-46 Added RSC Server

Step 4 On the camera list, drag the RSC server to the video output window.

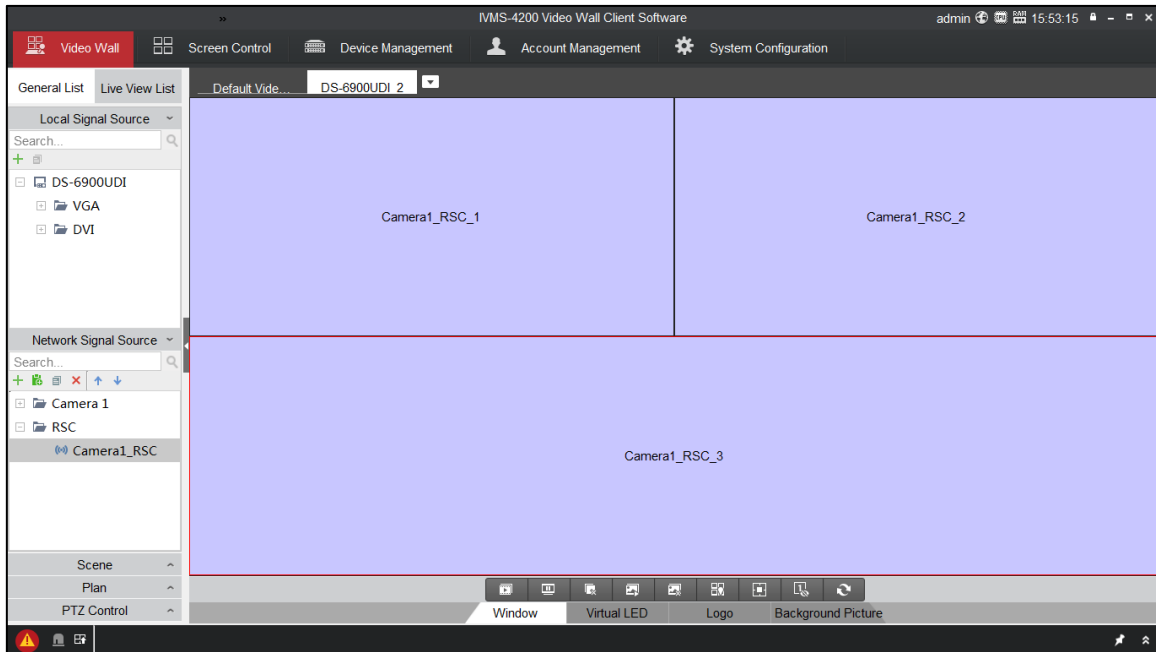

Figure 10-47 Link RSC to Video Wall

Step 5 Right-click on the window and select **Screen Control** to remotely control the signal source.

 **NOTE**

The RSC server supports the screen control for 1-channel video output only.

Step 6 You can use the toolbar on the window's upper right corner to realize the operations for image, video, PPT and remark.

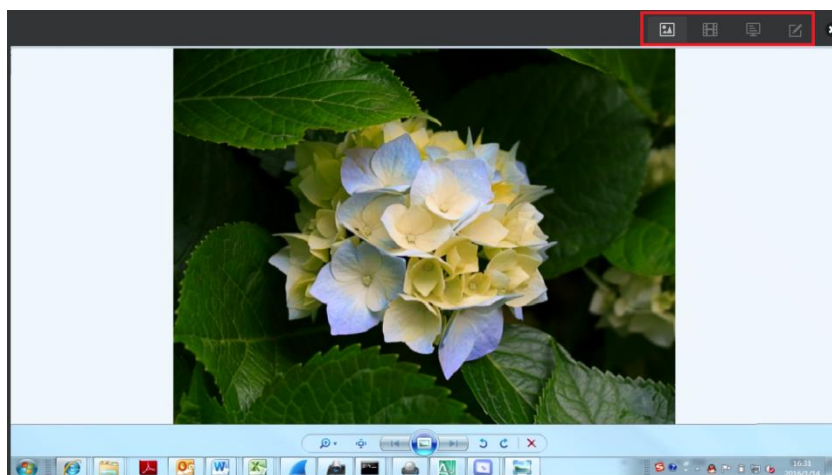

Figure 10-48 Screen Control Interface

- Click  to display all the image files in the directory set in the RSC Sever.

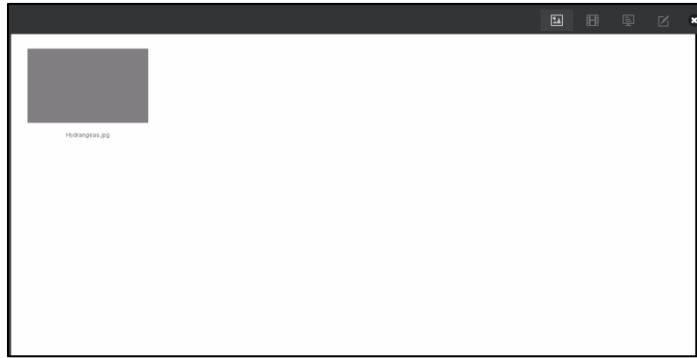



Figure 10-49 Screen Control Interface (1)

- Click  to display all the video files in the directory set in the RSC Sever.



Figure 10-50 Screen Control Interface (2)

- Click  to display all the PPT files in the directory set in the RSC Sever.

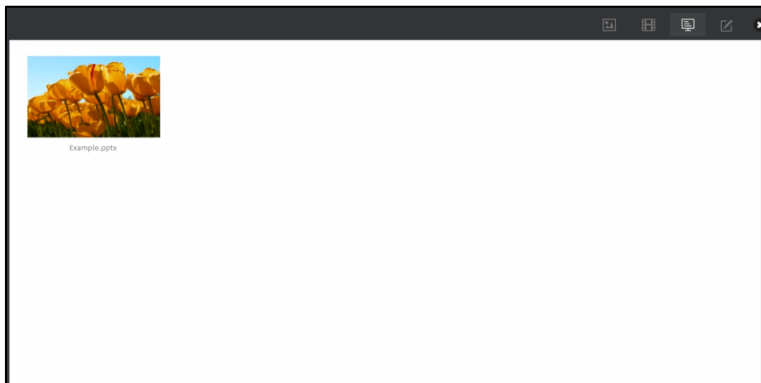

Figure 10-51 Screen Control Interface (3)

- Click  to pop up the following remark tool bar. You can select a color and set the line width to make remarks on the PPT.



Figure 10-52 Remark Tool Bar

10.9 Remote Configuration

Purpose

On the Remote Configuration interface, you can configure the parameters of the added device, including the system, network, event, etc..

Step 1 On the Device Management interface, click to select an added device from the list and click **Remote Configuration** to enter Remote Configuration interface.

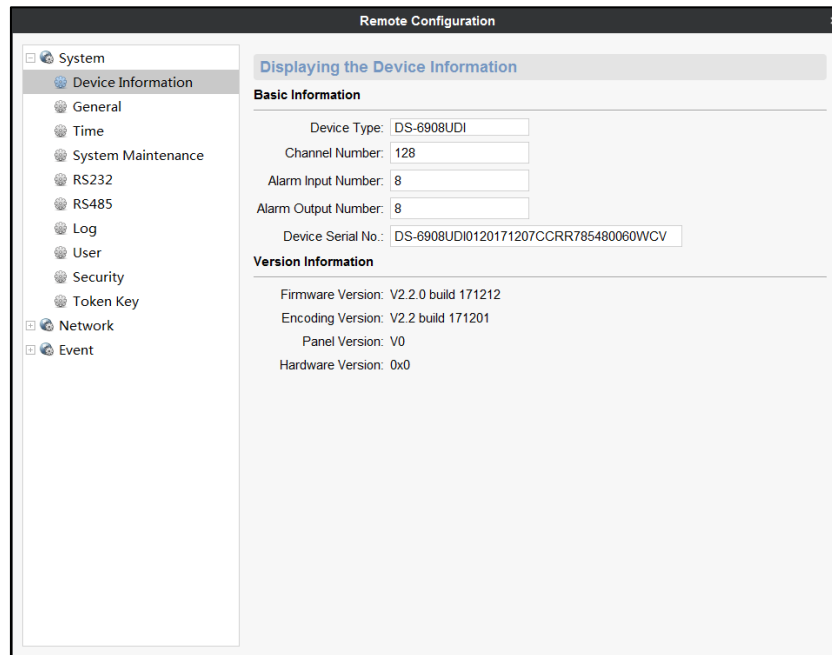

Figure 10-53 Remote Configuration

Step 2 Configure the System parameters, Network parameters and Event parameters on the Remote Configuration interface.

10.9.1 Configuring Ethernet Channel

Purpose

The Ethernet Channel is port link aggregation technology or port-channel architecture used for the connection between the switches.

Step 1 Click **Remote Configuration > Network > Ethernet Channel** to enter the Ethernet Channel Settings interface.

Step 2 Select a link number from the list.

Step 3 Check the checkbox to select the network interfaces to form a channel-group link, which can effectively enhance the link transmission bandwidth.

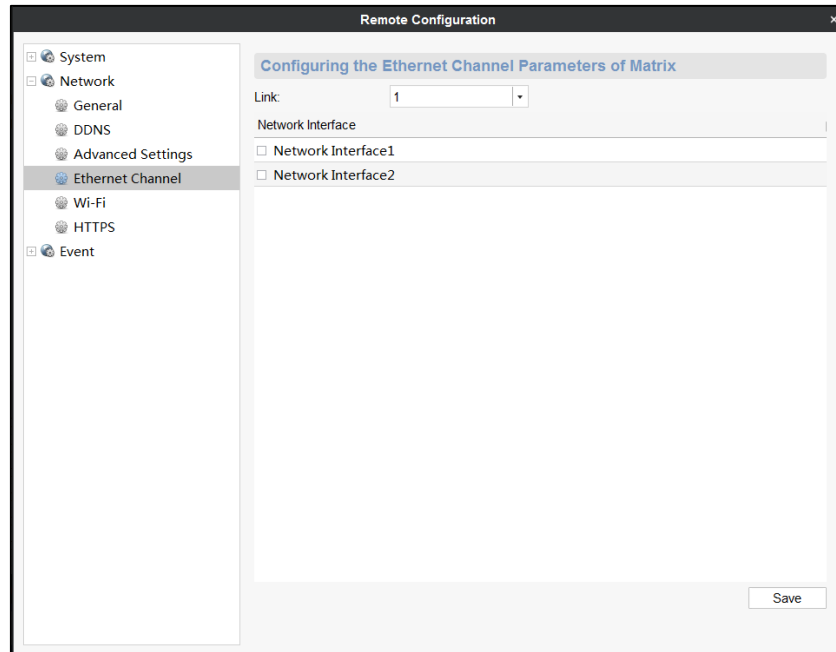

Figure 10-54 Ethernet Channel Settings

 **NOTE**

- The Ethernet Channel is not supported by DS-6901UDI.
- The switch connected to DS-6900UDI must be configured with the Ethernet Channel as well.
- Two adjacent network interfaces cannot be selected to form a link. For example, you can select Network Interface 1 and Network Interface 3, or Network Interface 2 and Network Interface 4.
- The network interface 1 corresponds to the GE1 interface, network interface 2 to G1, network interface 3 to GE2, and network interface 3 to G2 on the rear panel.
- The G1 and G2 can be used as 2G switch when the network interface 2 and network interface 4 are configured in Ethernet Channel.

10.10 Stream Media Server Configuration

Purpose

When the device network access channel number reaches the limit, or the network bandwidth is limited, you can realize real-time data transmission via stream media server to decrease the network pressure of the device.

10.10.1 Installing Stream Media Server

When you install iVMS-4200 video wall client software, install stream media server in the same layer of directory of the video wall client software.

10.10.2 Running Stream Media Server

Double click the desktop shortcut icon , or enter the installation directory (default: iVMS-4200 Video Wall\iVMS-4200 Stream Media Server), to open the stream media server. The main page is shown as below.

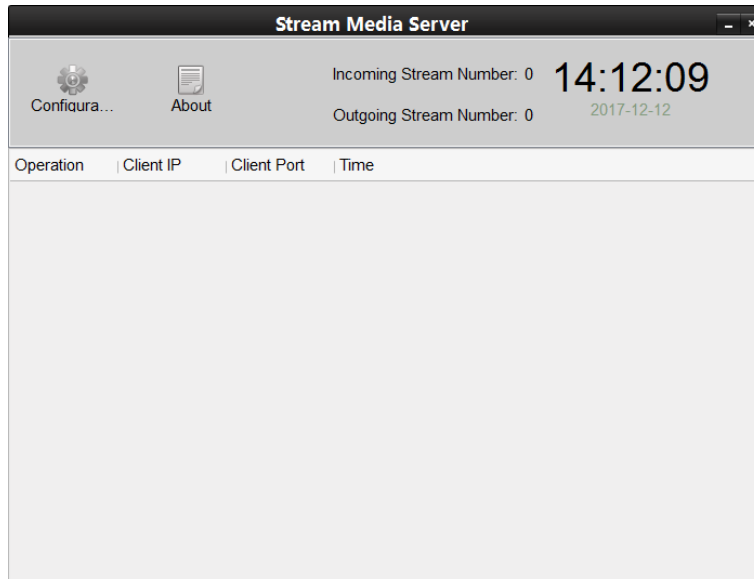



Figure 10-55 Stream Media Server

 will appear in the taskbar in the lower right corner of the desktop, indicating the server is running normally.

10.10.3 Adding Stream Media Server

Step 1 Open iVMS-4200 video wall client software.

Step 2 Click **Device Management**.

Step 3 Click **Add SMS**.

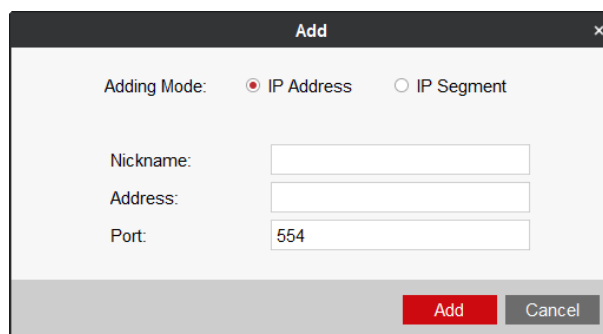

Figure 10-56 Add Stream Media Server

Step 4 Input **Nickname**, **Address**, and **Port**.

Step 5 Click **Add** to add the server.

10.10.4 Configuring Stream Media Server

● In Default Disabled Token Authentication Mode



NOTE

Token authentication is disabled by default. In the default disabled mode, follow the steps below to configure stream media server.

Step 1 Select the added stream media and click **SMS Settings** on **Device Management** interface to set stream media server.

- 1) Check the groups or channels needing to get stream via stream media.
- 2) Click **OK** to save the settings.

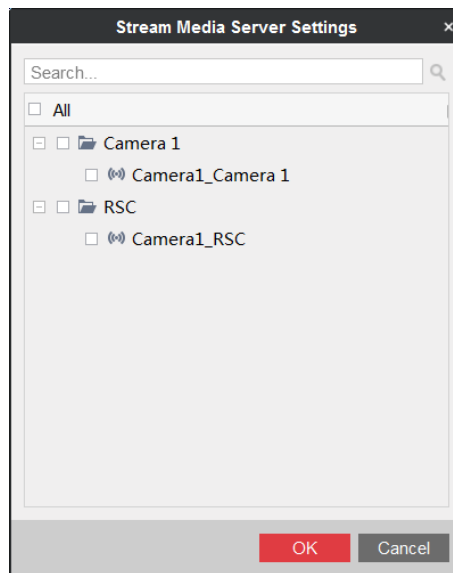
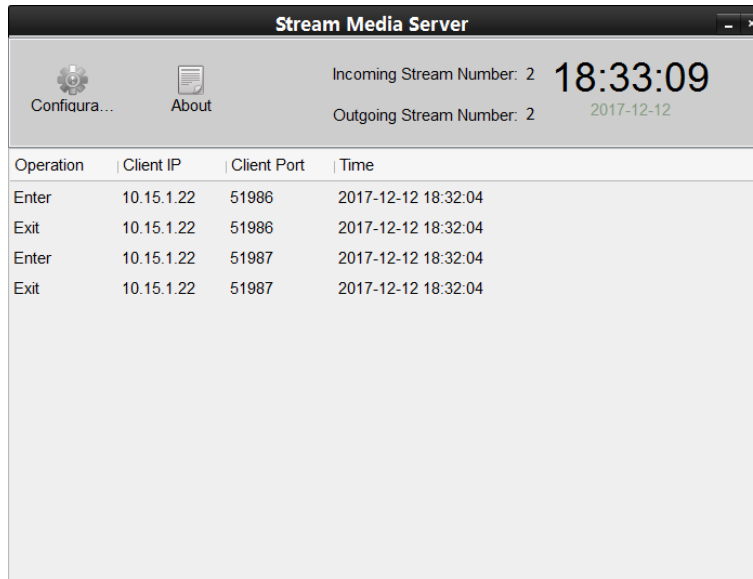

Figure 10-57 Stream Media Server Settings

Result: The groups or channels getting stream via stream media will get stream again via stream media. Open the stream media server, and the channels getting stream via stream media will be displayed.



The screenshot shows the 'Stream Media Server' application window. At the top, there are buttons for 'Configura...' and 'About'. The status bar displays 'Incoming Stream Number: 2' and 'Outgoing Stream Number: 2' along with a large digital clock showing '18:33:09' and the date '2017-12-12'. Below this is a table with the following data:

Operation	Client IP	Client Port	Time
Enter	10.15.1.22	51986	2017-12-12 18:32:04
Exit	10.15.1.22	51986	2017-12-12 18:32:04
Enter	10.15.1.22	51987	2017-12-12 18:32:04
Exit	10.15.1.22	51987	2017-12-12 18:32:04

Figure 10-58 Stream Media Status

● In Enabled Token Authentication Mode



You can enable token authentication by editing Setup file of iVMS-4200 Video Wall Client and Plugin file of iVMS-4200 Video Wall Stream Media Server. In the enabled mode, follow the steps below to enable token authentication and configure stream media server.

Before you start

Step 2 After the installation of iVMS-4200 video wall client, go to the installation directory of iVMS-4200 video wall client (default: C:\Program Files\iVMS-4200 Video Wall\iVMS-4200 Video Wall Client).

Step 3 Select *Setup.xml*.

Step 4 Right click the file and click **Edit**.

Step 5 Change `<Value>>false</Value>` of `<StreamServerIdentityAuthentication>` to `<Value>>true</Value>`.

```

<StreamServerIdentityAuthentication>
  <Value>true</Value>

```

Figure 10-59 Edit Setup File

Step 6 Save the settings.

Step 7 After the installation of stream media server, go to the installation directory of stream media server (default: C:\Program Files\iVMS-4200 Video Wall\iVMS-4200 Video Wall Stream Media Server).

Step 8 Select *Plugin.xml*.

Step 9 Right click the file and click **Edit**.

Step 10 Edit `<identify enable="0"/>` to `<identify enable="1"/>` to enable token authentication.

`<identify enable="1"/>`

Figure 10-60 Edit Plugin File

Step 11 Save the settings.

Steps

Step 1 Click **System Configuration** of iVMS-4200 video wall client software.

Step 2 Click **Export** to export **Stream Media Safety Authentication Configuration** to the local PC.

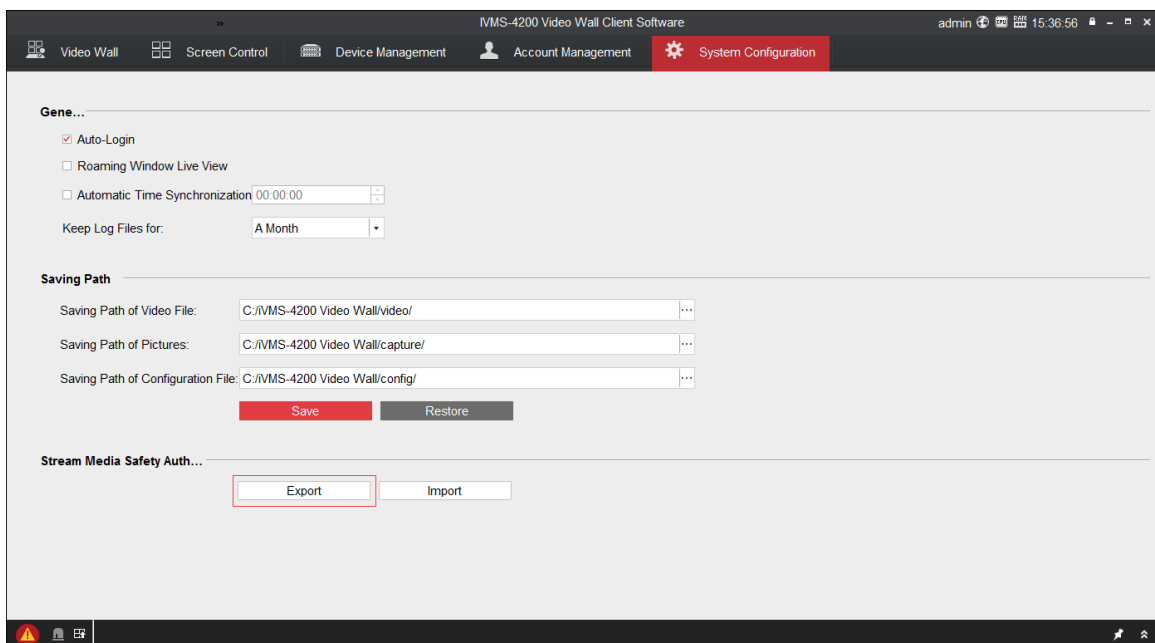

Figure 10-61 Export Stream Media Safety Authentication Configuration

Step 3 Import the stream media safety authentication configuration to the stream media server.

- 1) Run the stream media server.
- 2) Click **Configuration**.
- 3) Click **Import** to import the stream media safety authentication configuration to the server.

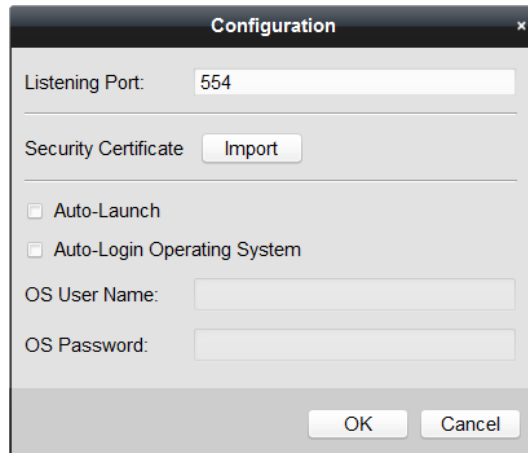

Figure 10-62 Import Stream Media Safety Authentication Configuration

- 4) Reboot the server to take the settings into effect.

Step 4 Import the stream media safety authentication configuration to the decoder via iVMS-4200 video wall client software.

- 1) Add the decoder to the iVMS-4200 video wall client software. Refer to *Chapter 10.2 Adding an Encoding/Decoding Device* for details.
- 2) Click **Remote Configuration**.
- 3) Go to **System > Token Key**.
- 4) Check **Enable Token Authentication**.
- 5) Click **Import Token Authentication Information** to import the XML file exported to the local PC before. After import, the key content will generate in **Key** text filed.
- 6) Select **Not Fill** for **Encryption Algorithm Filling Format**.
- 7) Click **Save** to save the settings.

 **NOTE**

For the other parameters of token configuration, remain the default settings.

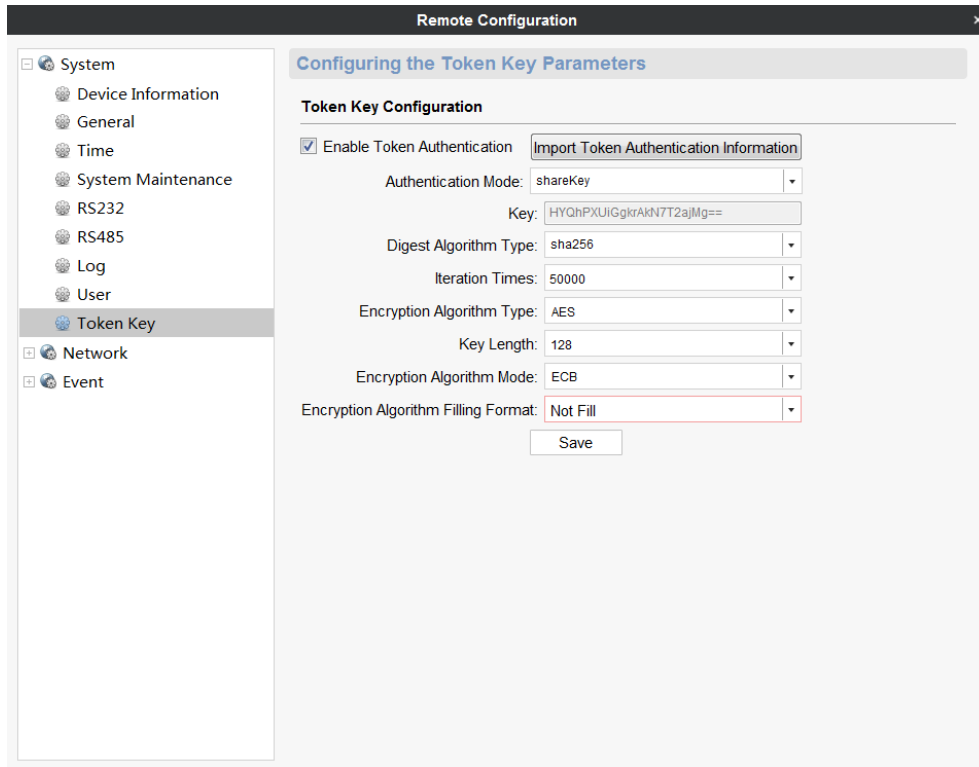

Figure 10-63 Token Configuration

Step 5 Select the added stream media and click **SMS Settings** on **Device Management** interface to set stream media server.

- 3) Check the groups or channels needing to get stream via stream media.
- 4) Click **OK** to save the settings.

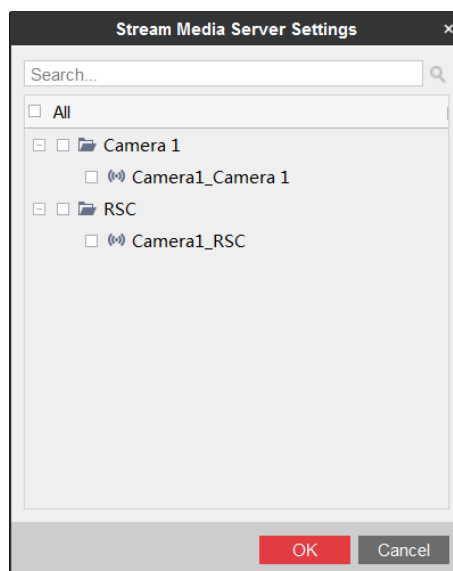

Figure 10-64 Stream Media Server Settings

Result: The groups or channels getting stream via stream media will get stream again via stream media. Open the stream media server, and the channels getting stream via stream media will be displayed.

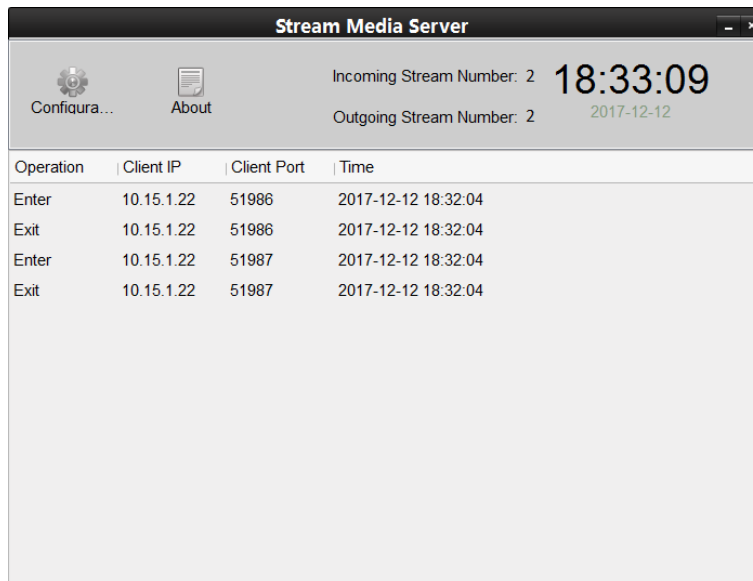

Figure 10-65 Stream Media Status

Chapter 11 Appendix

11.1 Specifications

Table 11-1 DS-6901/6904/6908 UDI Specification

Model		DS-6901UDI	DS-6904UDI	DS-6908UDI
Video/Audio output	VGA and DVI-I input	/	WSXGA: 1680×1050@60Hz WXGA: 1440×900@60Hz WXGA:1280×800@60Hz, 1366×768@60Hz, 1080p: 1920 × 1080@50/60Hz UXGA: 1600 × 1200@60Hz XVGA: 1280 × 960@60Hz 720p: 1280 × 720@50Hz/60Hz SXGA: 1280 × 1024@60Hz XGA: 1024 × 768@60Hz	
	Video/Audio output	HDMI output	1-ch	4-ch
VGA output		4K: 3840 × 2160@30Hz (for even interface only) 1080p: 1920 × 1080@50/60Hz WSXGA: 1680×1050@60Hz UXGA: 1600 × 1200@60Hz (for even interface only) 720p: 1280 × 720@50Hz/60Hz SXGA: 1280 × 1024@60Hz XGA: 1024 × 768@60Hz		
		BNC output	1-ch	2-ch, 1 DB 15
Audio/ Video decoding	Decoding resolution	Up to 12MP		
	Decoding channel	16-ch	32-ch	64-ch

	Decoding capability	12MP@20fps: 2-ch 8MP@30fps: 4-ch 5MP@30fps: 6-ch 3MP@30fps: 10-ch 1080p@30fps: 16-ch	12MP@20fps:4-ch 8MP@30fps: 8-ch 5MP@30fps: 12-ch 3MP@30fps: 20-ch 1080p@30fps: 32-ch	12MP@20fps:8-ch 8MP@30fps: 16-ch 5MP@30fps: 24-ch 3MP@30fps: 40-ch 1080p@30fps: 64-ch
	Split screen	1/4/6/8/9/12/16	1/4/6/8/9/12/16/25	1/4/6/8/9/12/16/25/36
External interface	Network interface	1; 10/100/1000 Mbps self-adaptive Ethernet interface	2; 10/100/1000 Mbps self-adaptive management network interface 2; 10/100/1000 Mbps self-adaptive Ethernet interface 16; 10M/100Mbps self-adaptive Ethernet interface Wi-Fi interface	
	Serial interface	1 RS-232 (RJ 45), 1 RS-485		
	Two-way audio in	1-ch, 3.5 mm connector (2.0 Vp-p, 1 k Ω)		
	Two-way audio out	1-ch, 3.5 mm connector (2.0 Vp-p, 1 k Ω)		
	Audio output	1-ch	4-ch, 1 DB 15	8-ch, 1 DB 15
	Alarm in	8-ch		
	Alarm out	8-ch		
General	Power supply	12 VDC	100 to 240 VAC	
	Power consumption	≤ 15 W	≤ 70 W	
	Working temperature	-10° C to 55° C (14° F to 131° F)		
	Working humidity	10% to 90%		
	Dimensions (W × D × H)	220 × 148 × 45 mm (8.66" × 5.83" × 1.77")	440 × 311 × 44.5 mm (17.32" × 12.24" × 1.75")	
	Weight	≤ 1.2 kg (2.65 lb)	≤ 5.2 kg (11.4 lb)	

Table 11-2 DS-6910/6912/6916 UDI Specification

Model		DS-6910UDI	DS-6912UDI	DS-6916UDI
Video/ Audio output	VGA and DVI-I input	WSXGA: 1680×1050@60Hz WXGA: 1440×900@60Hz WXGA: 1280×800@60Hz, 1366×768@60Hz, 1080p: 1920 × 1080@50/60Hz UXGA: 1600 × 1200@60Hz XVGA: 1280 × 960@60Hz 720p: 1280 × 720@50Hz/60Hz SXGA: 1280 × 1024@60Hz XGA: 1024 × 768@60Hz		
	HDMI output	10-ch	12-ch	16-ch
Video/ Audio output	BNC output	5-ch, 2 DB 15	6-ch, 2 DB 15	8-ch, 2 DB 15
	Decoding resolution	Up to 12MP		
Audio/ Video decoding	Decoding channel	80-ch	96-ch	128-ch
	Decoding capability	12MP@20fps: 10-ch 8MP@30fps: 20-ch 5MP@30fps: 30-ch 3MP@30fps: 50-ch 1080p@30fps: 80-ch	12MP@20fps: 12-ch 8MP@30fps: 24-ch 5MP@30fps: 36-ch 3MP@30fps: 60-ch 1080p@30fps: 96-ch	12MP@20fps:16-ch 8MP@30fps: 32-ch 5MP@30fps: 48-ch 3MP@30fps: 80-ch 1080p@30fps/3 Mbps: 128-ch
	Split screen	1/4/6/8/9/12/16/25/36		

External interface	Network interface	2; 10/100/1000 Mbps self-adaptive management network interface 2; 10/100/1000 Mbps self-adaptive Ethernet interface 16; 10M/100 Mbps self-adaptive Ethernet interface		
	Serial interface	1 RS-232 (RJ 45), 1 RS-485		
	Two-way audio in	1-ch, 3.5 mm connector (2.0 Vp-p, 1 k Ω)		
	Two-way audio out	1-ch, 3.5 mm connector (2.0 Vp-p, 1 k Ω)		
	Audio output	10-ch, 2 DB 15	12-ch, 2DB 15	16-ch, 2 DB 15
	Alarm input	8		
	Alarm out	8		
General	Power supply	100 to 240 VAC		
	Power consumption	≤ 108 W		
	Working temperature	-10° C to +55° C (+14° F to +131° F)		
	Working humidity	10% to 90%		
	Dimensions (W × D × H)	440 × 311 × 80 mm (17.32" × 12.24" × 3.15")		
	Weight	≤ 6.4 kg (14.11 lb)		

11.2 FAQ

- Why cannot ping the decoder?
 - Check the cable and the switch.
 - Please refer to *Chapter 4* to configure the IP address of the decoder.
- Why cannot connect the decoder with client software?
 - Check the decoder IP address.
 - Cable is connected.
 - User name and password of decoder are correct.
- Why cannot play back the record files in DVR with decoder?
 - Check the DVR network connection.
 - Check the parameters of the playback file.
 - Check if there are files existed in the selected time duration.
- Why cannot decode the stream transported by stream media server?
 - Check the network connection between decoder and stream media server.
 - Check if the stream media server port is connected with the port added on decoder.

11.3 List of Third-Party IP Cameras Access

IP Camera Manufacturer	Model	Supported Video Format
Panasonic	SP306H	H.265+. H.265, H.264, H.264+, MJPEG, MPEG4,
	SP336H	
Sony	SNC-CH220	
	SNC-RH124	
Axis	P5532	
	Q7404	
Sanyo	VCC-HD2500P	
SAMSUNG	SND-5080P	
Bosch	NBC265P	
Zavio	D5110	
Arecont	AC1305M	
Pelco	IX30DN-ACFZHB3	
Onvif	Supported	



See Far, Go Further